



**WINN**

**MADE IN GERMANY**

**BÜSCHE**

**BÜSCHE**  
**150**  
*years*  
\*— Anniversary —\*

It is with pride and gratitude that I look back on the 150-year history of BÜSCHE. Since 1872, BÜSCHE has been developing, manufacturing and selling products exclusively with the label „Made in Germany“.

For generations, the name BÜSCHE stands for tradition combined with the strong desire to actively shape the future. The focus is on sustainability, social responsibility and the continuous development of the BÜSCHE brand.

My heartfelt thanks go to all those who have accompanied us on this long journey and whose thoughts and actions have made BÜSCHE GmbH & Co. KG into a globally successful family business.

Fernando Sanchez



# CURTAIN SETS MADE IN GERMANY

VION offers the entry into the world of high-quality BÜSCHE curtain sets - developed, manufactured and finished in Neuenrade/ South Westphalia. The materials stainless steel and aluminum coming from Germany are processed and refined by a complex process.

With diameters of 10, 16, 20, 24, 28 and 35 mm, a large selection of finials and accessories, BÜSCHE products fulfill the company's high quality standards.

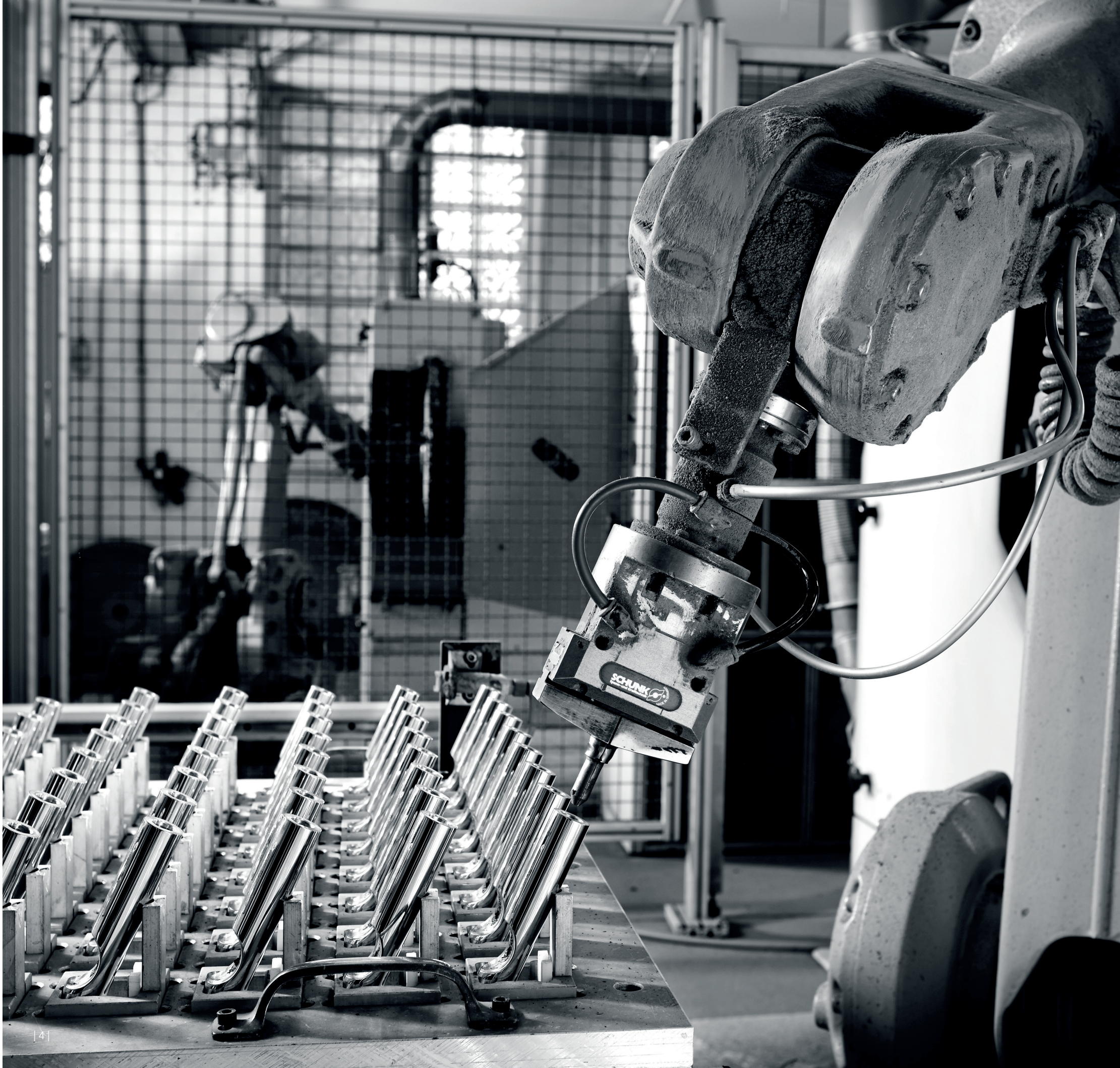

# QUALITY IN ALL AREAS MADE IN GERMANY

The term quality describes the overall impression of a product in terms of technical precision, design, haptics and sustainability. As one of the few German suppliers of curtain sets, BÜSCHE manufactures its products exclusively in Neuenrade with the predicate „Made in Germany“.

Process-optimized production methods and the craftsmanship of dedicated employees create the basis for excellent functionality and durability. In close cooperation with international product designers, new shapes and unique products are created: unmistakable, unique and with the highest precision.

**VI  
ON**

MADE IN GERMANY

**BUSCHE**

**IN  
SIDE**

MADE IN GERMANY

**BUSCHE**

**TEC  
DOR**

MADE IN GERMANY

**BUSCHE**

**TEC  
DOR**

MADE IN GERMANY

**IQ-Series**

**BUSCHE**

# THE BÜSCHE BRAND STRATEGY

The umbrella brand BÜSCHE and the associated brands VION, INSIDE and TECDOR provide wholesalers all over the world with a unique product portfolio of curtain sets and accessories for window decoration.

With a clear commitment to national and international wholesalers, BÜSCHE underlines its reliability and sets clear accents in the cooperation with its partners. BÜSCHE offers the retail trade a unique variety of products combined with a high level of security, exclusivity, reliability and support.





# BÜSCHE FOCUSED ON RESPONSIBILITY

Craftsmanship, high-quality materials from sustainable German production, CO<sub>2</sub>-optimized manufacturing processes, the increasing use of lead-free brass and packaging materials reduced to the essentials are just a few examples of the ecological responsibility in the BÜSCHE philosophy.

All products are manufactured by hand according to European environmental guidelines and are anodized or electroplated depending on the finish.

Only solid turned and milled products are used. The result are finishes with an impressive appearance and individual color tones.

High qualified employees and the use of modern CNC-controlled production machines and robotic systems guarantee a quality that is appreciated by customers all over the world. Visit us in Neuenrade and convince yourself of the diversity of our production and the unique quality „Made in Germany“.

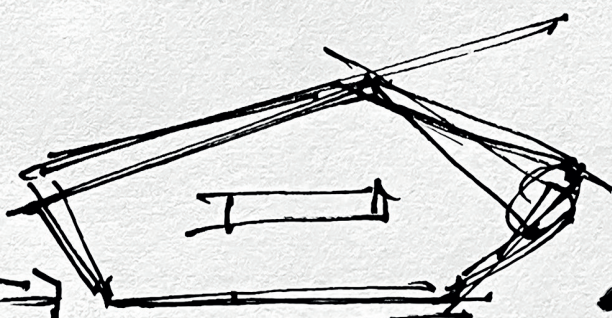

SEITE  
SCHWARZ  
ZEICHEN  
SIZES  
CHRON

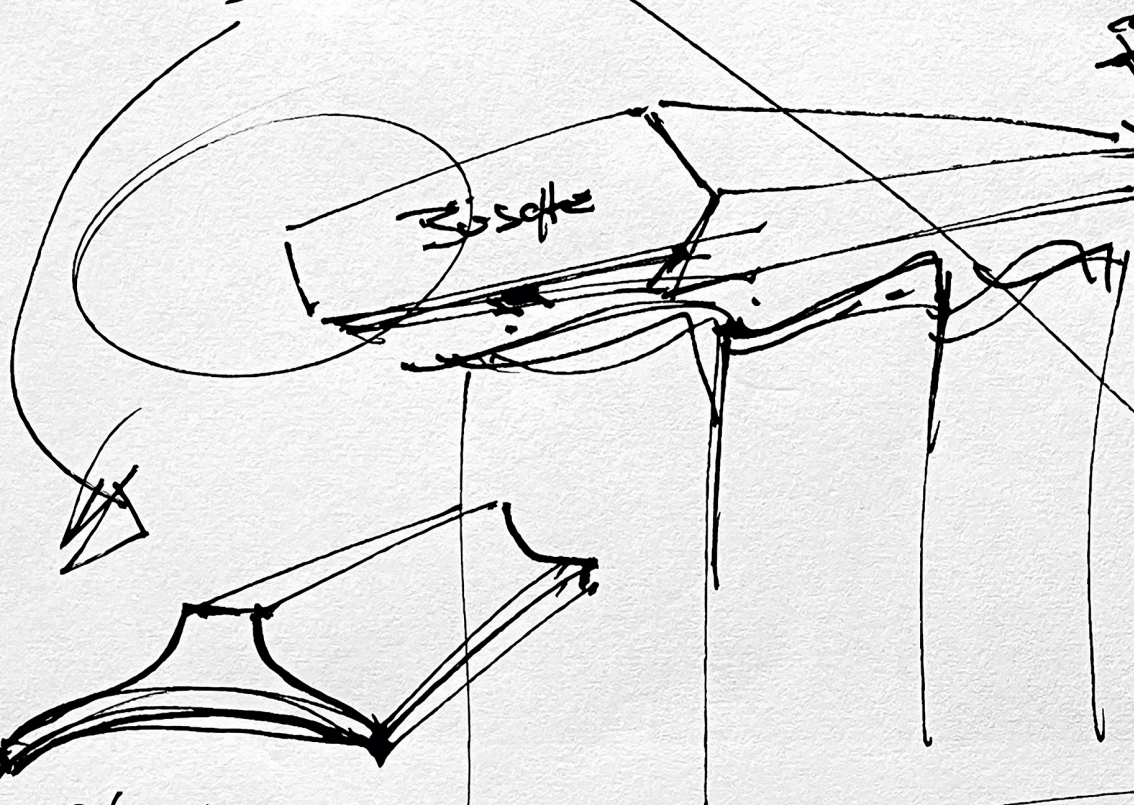

(A)

STATEMENT!!

ROUNDY

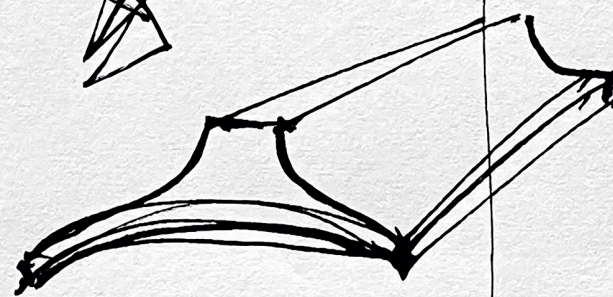

SPELIER

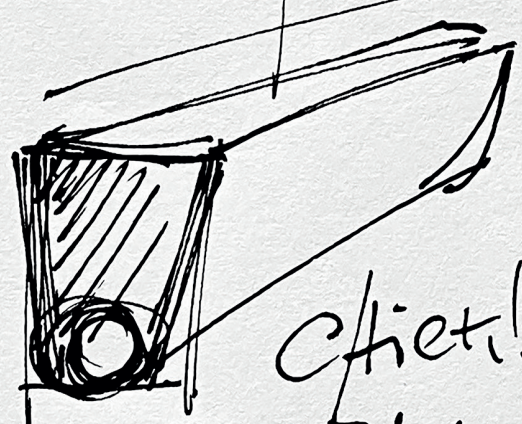

CHIEF!  
STALL

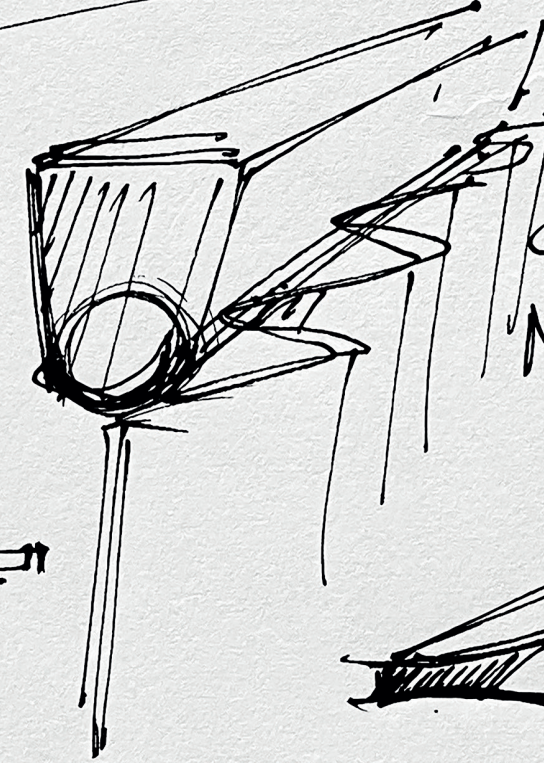

LOW  
CHRON  
NEOW?

NICHT  
SICHTBAR!

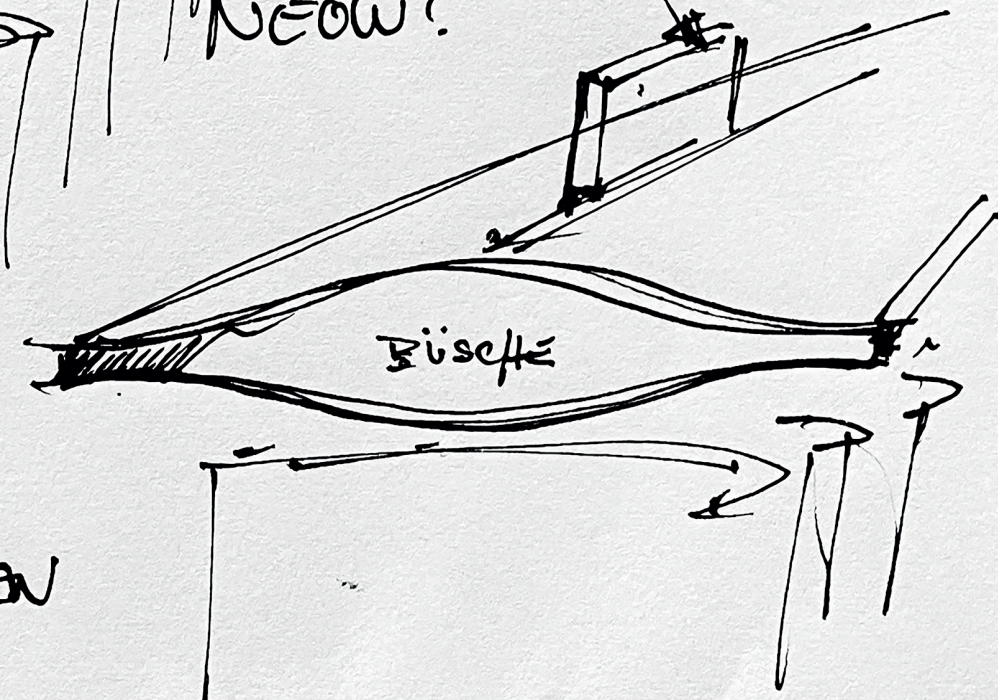
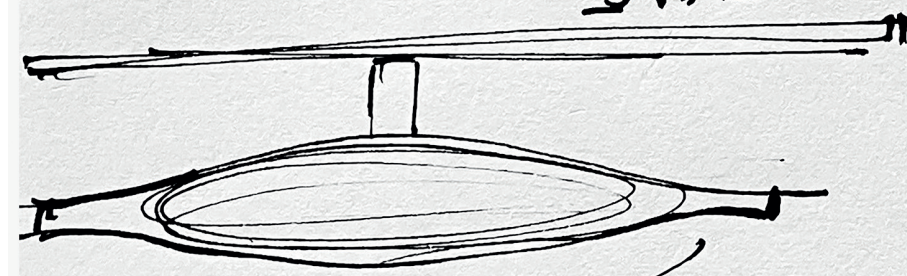

BÜSCHE

MILLING?

SCHWEBEN



# SCHMIDDEM PRODUCT DESIGN, LIVING PASSION.

Wishes, dreams, visions: Schmiddy Design delivers the designs. For Jochen Schmiddy, it's the little things that make a product into an experience. Each one is unique in form and concept, just as each company is unique. The result is a distinctive product that is precisely tailored to the wishes and targets of the client and its markets.

In the process, limits are crossed deliberately in order to create the perfect product by combining functionality, durability and emotionality.

This requires innovative companies that are interested in more than just the product; for whom innovation and sustainability are not just bold marketing words, but an integral part of the corporate culture, from the first draft to the finished product.

In BÜSCHE, Jochen Schmiddy has found the perfect partner. Seven new products - PUR, COS, LEP, BOW, NEXUS, COLAR and CALA - have been created, and some of them have already won several design awards.

Team spirit, trust, passion and innovative action characterize the BÜSCHE company: unmistakable, unique and manufactured with the highest precision.



1

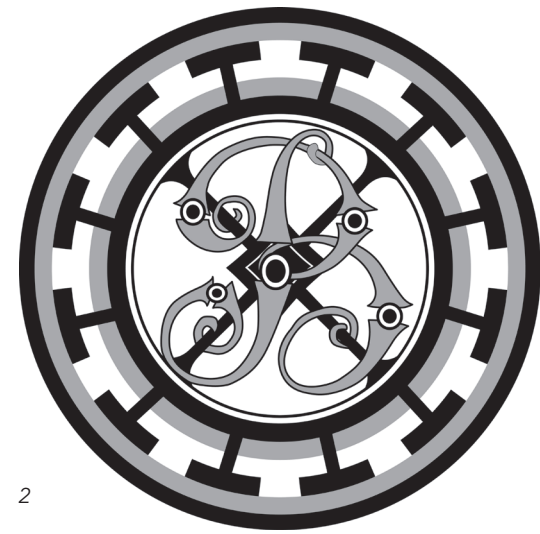

2

- 1 - Familienportrait um 1900
- 2 - Büsche Wappen um 1700
- 3 - Firmengebäude um 1950



3

# BÜSCHE

## 150 YEARS MADE IN GERMANY

The BÜSCHE company history began in 1872 with the foundation of a company for the production of wood screws by Heinrich Büsche. In the 50's and 60's, under the management of Fritz Büsche, the company began to produce hooks for wardrobes, rope fittings, eyelets, curtain rings, tie-backs, carpet rods and the first curtain sets.

### TECHNOLOGICAL PROGRESS AND EXPANSION

The expansion of the product portfolio and the increasing globalization of the BÜSCHE brand led to continuous technological development in all areas of the company over the following decades. Existing systems were replaced by modern CNC machines, environmentally friendly cleaning systems and computer-controlled grinding and polishing robots.

### NEW BUILDING AND STRENGTHENING THE BÜSCHE BRAND

In 2014, BÜSCHE invested in the construction of a 2,300 m<sup>2</sup> logistics center, which is now used for order picking, storage of finished products, order processing and production. With the publication of the 2015 product catalog, the brands BÜSCHE INSIDE, BÜSCHE TECDOR and BÜSCHE VION were presented under the main brand BÜSCHE.

### ACTIVE MANAGEMENT OF THE FUTURE

This year BÜSCHE is celebrating its 150th anniversary. Time to look back with gratitude, but also an important occasion to look into the future.

In addition to strengthening the BÜSCHE brand, combined with the continuous development of products, finishes, optimization of gliding properties and services, the establishment of sustainable production is at the top of the agenda.

Already today, more and more materials from carbon-optimized production and lead-free brass are being processed. Investment in a new CNC turning machine suitable for processing this type of brass, a new exhaust system for the polishing department to protect employees and the environment, and the installation of a degreasing system based on the latest environmental regulations are all planned for this anniversary year.

With the purchase of an adjoining commercial property of 3,000 m<sup>2</sup> for production and assembly, BÜSCHE GmbH & Co. KG has set another example for a sustainable, socially responsible and successful future.

*Shareholders and General Managers from 1872 UNTIL TODAY*

*1872 - 1923 Heinrich Büsche  
1923 - 1961 Fritz Büsche  
1958 - 2006 Harro Schumann  
1996 - 2014 Friedrich Harr  
1999 - today Fernando Sanchez*

**WIN  
ON**

**MADE IN GERMANY**

**BUSCHE**

# BÜSCHE

## VION

10 mm

---

stainless steel

Pole set no. **1-1100-116**



Available finishes



-116 stainless steel







Ø 10 mm

# Ø 10 mm Decorative Pole Sets

WALL INSTALLATION / ROD SINGLE

---



CAFÉ ROD - stainless steel - Page 36 - Pole set no. 3-1120-116



CAFÉ ROD - stainless steel - Page 36 - Pole set no. 4-1120-116

AVAILABLE FINISHES



-116 stainless steel







ALBA - stainless steel - Page 36 - Pole set no. 1-1100-116

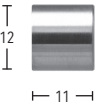
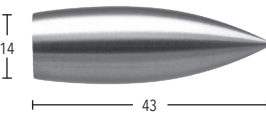
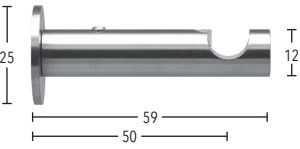
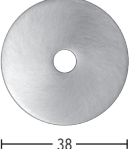
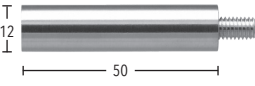

NELON - stainless steel - Page 36 - Pole set no. 1-1102-116

Ø 10 mm

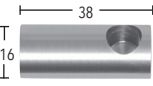
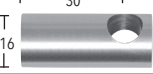
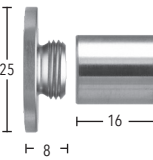
# Ø 10 mm Accessories

	ARTICLE	FINISH	ARTICLE NO.		
	<b>STAINLESS STEEL-TUBE</b> Ø 10 mm  Price € per metre standard length 6 m	stainless steel	800-10-116	fix length (cut to size)	std. length
	<b>END CAP ALBA</b> for Ø 10 mm  PU = 10	stainless steel	103000-116		
	<b>FINIAL NELON</b> for Ø 10 mm  PU = 10	stainless steel	103002-116		
	<b>WALL BRACKET NOX (System 1-)</b> single, wall ext. 50 mm with stud srew for Ø 10 mm  PU = 10	stainless steel	104050-116		
	<b>WALL PLATE, alternatively</b> with 3-hole mounting plate for wall bracket NOX  PU = 10	stainless steel	105101-116		
	<b>EXTENSION</b> length 50 mm for wall bracket NOX  PU = 10	stainless steel	106050-116		
	<b>CAFÉ ROD-WALL BRACKET (System 3-)</b> <b>CAFÉ ROD-WALL MIDDLE BRACKET</b> single / wall ext. 14 mm for Ø 10 mm  PU = 10	stainless steel	21016-10-116		
		stainless steel	21017-10-116		
	<b>CAFÉ ROD-WALL BRACKET (System 4-)</b> <b>CAFÉ ROD-WALL MIDDLE BRACKET</b> single / wall ext. 30 mm for Ø 10 mm  PU = 10	stainless steel	21018-10-116		
		stainless steel	21019-10-116		
	<b>RECESS BRACKET</b> for Ø 10 mm  PU = 10	stainless steel	107001-116		
	<b>FLAT CURTAIN RING</b> i.d. 28 mm, o.d. 32 mm  PU = 100	stainless steel	225720-116		

# Ø 10 mm Accessories

	ARTICLE	FINISH	ARTICLE NO.
	<b>SEC. RING CLIP</b> <b>SEC. RING CLIP WITH EYELET</b> for flate curtain rings art. no. 225720-116  PU = 100	transparent transparent	718-4-00 722-4-00
	<hr/>		
	<b>FLAT CURTAIN RING WITH PLASTIC INSERT</b> i.d. 27 mm / o.d. 34 mm  PU = 50	sat. nickel	125820-29
<hr/>			
	<b>SEC. RING CLIP</b> for flate curtain rings with plastic insert Article No. 125820-29  PU = 100	transparent silver	844-00 -29
<hr/>			
	<b>FLAT CURTAIN RING WITH EYELET</b> and plastic insert i.d. 27 mm / o.d. 34 mm  PU = 50	sat. nickel	125920-29
<hr/>			

Ø 10 mm

# Ø 10 mm Illustrations

---

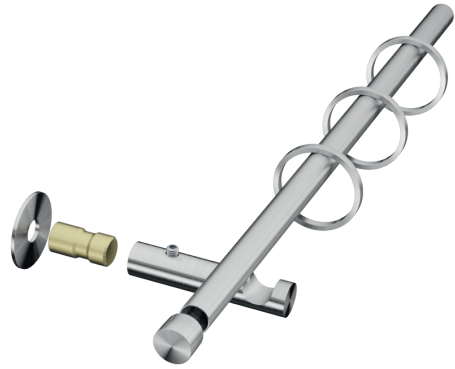

Wall bracket tube installation  
art. no. 104050-116

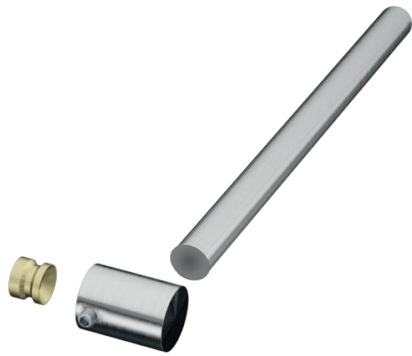
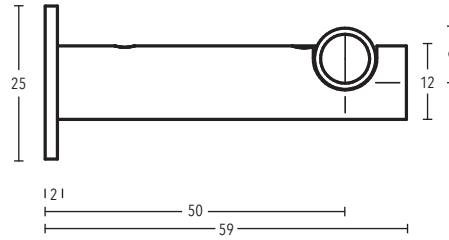

Café rod-wall bracket  
art. no. 21016-10-116 + 21018-10-116

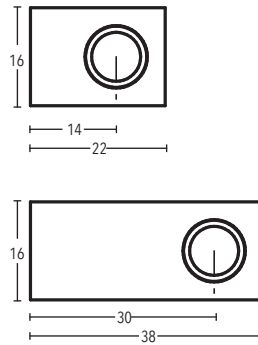

Recess bracket  
art. no. 107001-116

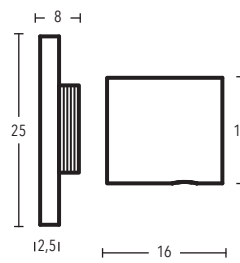

# BÜSCHE

## VION

16 mm

---

stainless steel

Pole set no. **4-1706-116**



Available finishes



-116 stainless steel





Ø 16 mm



# Ø 16 mm Decorative Pole Sets

WALL- AND CEILING INSTALLATION / TUBE SINGLE/DOUBLE / RAIL SINGLE/DOUBLE

---



ALBA - stainless steel - Page 48 - Pole set no. 1-1700-116

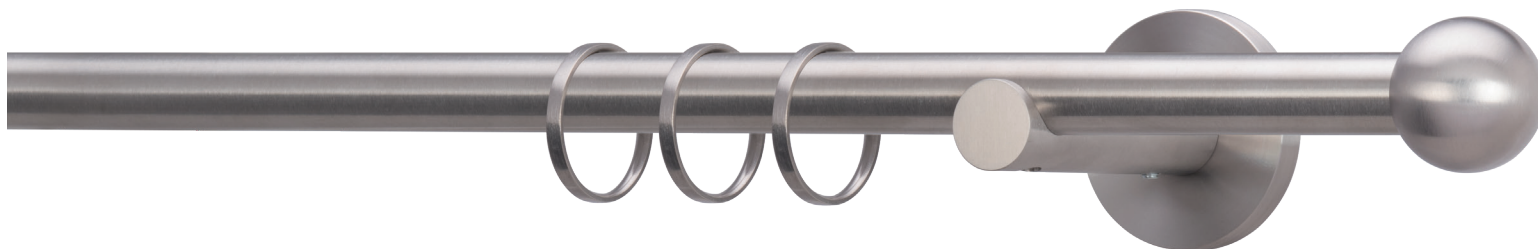

TERA - stainless steel - Page 50 - Pole set no. 1-1701-116

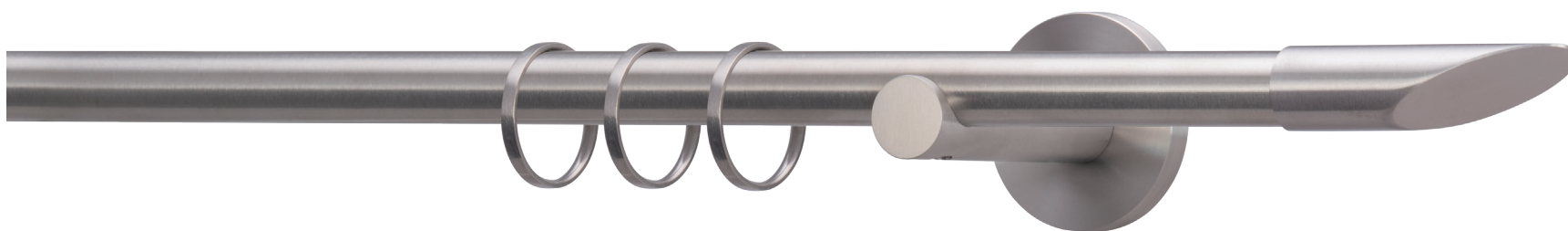

DUNA - stainless steel - Page 50 - Pole set no. 1-1704-116



ELANO / ALBA - stainless steel - Page 50 - Pole set no. 2-1709-116

AVAILABLE FINISHES



-116 stainless steel



LINE - stainless steel - Page 46 - Pole set no. 7-1790-116

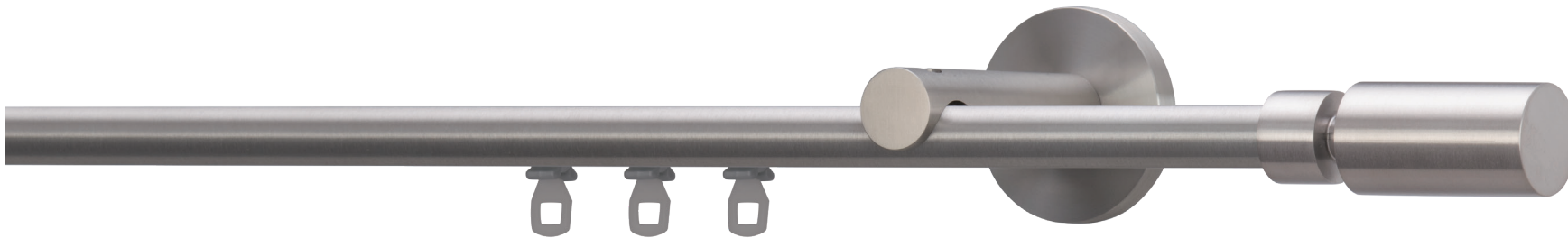

LANA - stainless steel - Page 50 - Pole set no. 4-1708-116

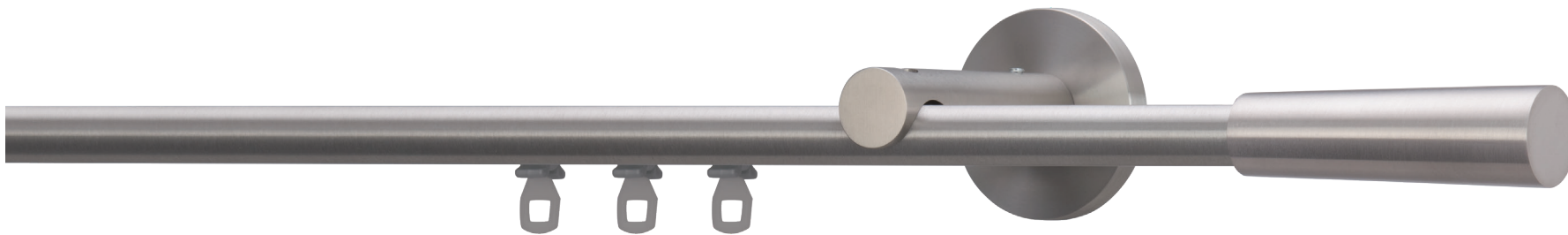



SINA - stainless steel - Page 50 - Pole set no. 4-1706-116





ORIM / LINE - stainless steel - Page 50 - Pole set no. 5-1724-116

Ø 16 mm

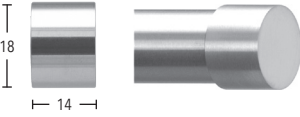
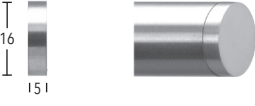
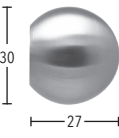
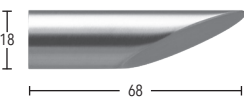
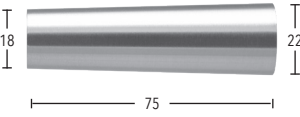
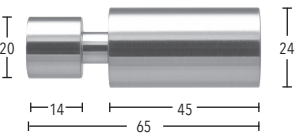
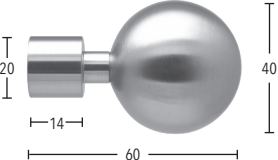
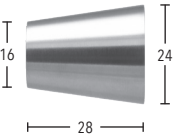
# Ø 16 mm Accessories



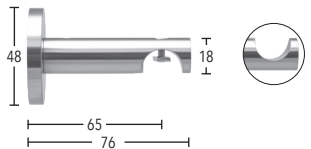
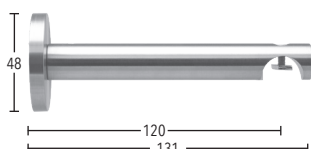
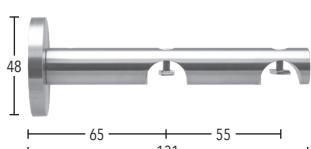
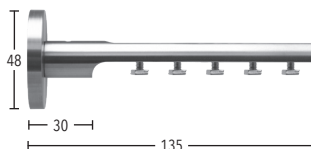

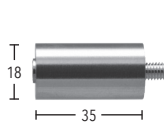
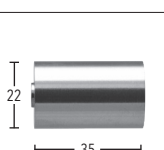
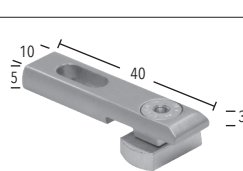
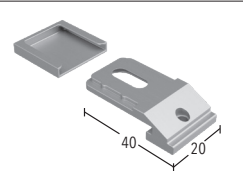
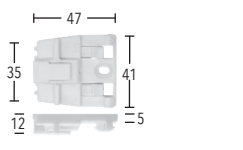

	ARTICLE	FINISH	ARTICLE NO.		
	<b>STAINLESS STEEL-TUBE</b> Ø 16 mm  standard length 6 m	stainless steel	800-16-116	fix length (cut to size)	std. length
	<b>ALUMINIUM-RAIL</b> Ø 16 mm  standard length 6 m	stainless steel	808-16-116	fix length (cut to size)	std. length
	<b>END CAP ALBA</b> for Ø 16 mm  PU = 10	stainless steel	163000-116		
	<b>END CAP LINE</b> for Ø 16 mm flush finish to fit with tube / rail of equal diameter  PU = 10	stainless steel	163100-116		
	<b>FINIAL TERA</b> for Ø 16 mm  PU = 10	stainless steel	163010-116		
	<b>FINIAL DUNA</b> for Ø 16 mm  PU = 10	stainless steel	163013-116		
	<b>FINIAL SINA</b> for Ø 16 mm  PU = 10	stainless steel	163015-116		
	<b>FINIAL LANA</b> for Ø 16 mm  PU = 10	stainless steel	163020-116		
	<b>FINIAL ELANO</b> for Ø 16 mm  PU = 10	stainless steel	163021-116		
	<b>FINIAL ORIM</b> for Ø 16 mm flush finish to fit with tube / rail of equal diameter  PU = 10	stainless steel	163031-116		

# Ø 16 mm Accessories

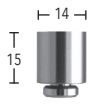
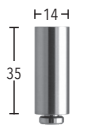

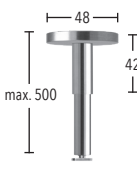
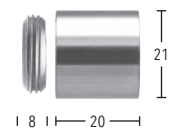
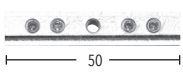
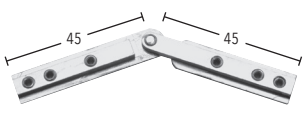
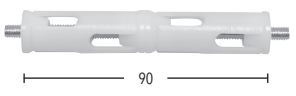
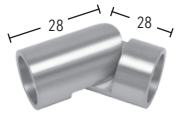
	ARTICLE	FINISH	ARTICLE NO.
	<b>WALL BRACKET ALUX (System 1- + 4-)</b> single, wall ext. 65 mm without cover (art. no. 165001) for Ø 16 mm tubes / rails  PU = 10	stainless steel	164065-116
	<b>WALL BRACKET ALUX</b> single, wall ext. 120 mm without cover (art. no. 165001) for Ø 16 mm tubes / rails  PU = 10	stainless steel	164120-116
	<b>WALL BRACKET ALUX (System 2- + 5-)</b> double, wall ext. 65/120 mm without cover (art. no. 165001) for Ø 16 mm tubes / rails  PU = 10	stainless steel	165120-116
	<b>MULTI-WALL BRACKET ALUX</b> for mounting of 1-5 rails wall ext. 40-135 mm for Ø 16 mm rails  PU = 10	stainless steel	205320-116
	<b>BORE HOLE INSERT FOR ALL BRACKETES ALUX</b> material stainless steel to cover bore holes when using the bracket as tube bracket  PU = 10	stainless steel	165001-116
	<b>EXTENSION</b> length 35 mm for all brackets »ALUX«  PU = 10	stainless steel	166035-116
	<b>SOCKET</b> for cut brackets »ALUX«  PU = 10	stainless steel	167002-116
	<b>CEILING BRACKET 3 mm (System 6-)</b> single, ceiling ext. 16 mm for rails  PU = 10	silver white	11592-00 -28
	<b>CEILING BRACKET 3 mm (System 11-)</b> including borehole cover single, ceiling ext. 16 mm for rails  PU = 10	silver white	11597-00 -28
	<b>SNAP-IN CEILING BRACKET 5 mm (System 10-)</b> single, ceiling ext. 18 mm Material: plastic for rails  PU = 10	white	11693-00

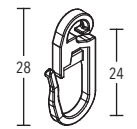
Ø 16 mm

# Ø 16 mm Accessories

	ARTICLE	FINISH	ARTICLE NO.
	<b>CEILING BRACKET 15 mm (System 7-)</b> single, ceiling ext. 28 mm for rails  PU = 10	stainless steel	164915-116
	<b>CEILING BRACKET 35 mm (System 8-)</b> single, ceiling ext. 48 mm for rails  PU = 10	stainless steel	164935-116
	<b>CEILING BRACKET 42 mm</b> single, ceiling ext. 55 mm with 3-hole mounting plate for rails  PU = 10	stainless steel	164942-116
	<b>CEILING BRACKET 500 mm</b> single, ceiling ext. 55-513 mm (can be cut) with 3-hole mounting plate for rails  PU = 1	stainless steel	164995-116
	<b>RECESS BRACKET</b> for Ø 16 mm  PU = 10	stainless steel	167001-116
	<b>RAIL CONNECTOR</b> for rails  PU = 10	silver	899-3-00
	<b>RAIL CONNECTOR</b> adjustable for rails PU = 10 »Mitring see info page 28«	silver	899-3.1-01
	<b>TUBE CONNECTOR</b> for Ø 16 mm tubes  PU = 10	white	83016-000
	<b>CONNECTOR (HINGED JOINT)</b> for Ø 16 mm tubes and rails  PU = 10	stainless steel	122916-116
	<b>FLAT CURTAIN RING</b> i.d. 28 mm, o.d. 32 mm  PU = 100	stainless steel	225720-116
 	<b>SEC. RING CLIP</b> <b>SEC. RING CLIP WITH EYELET</b> for flat curtain ring art. no. 225720-116  PU = 100	transparent transparent	718-4-00 722-4-00

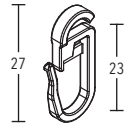
# Ø 16 mm Accessories

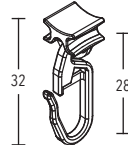
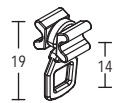
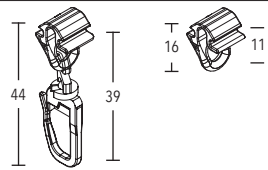
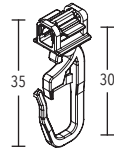
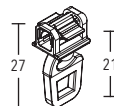
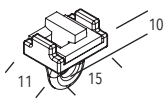
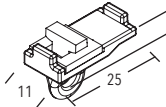
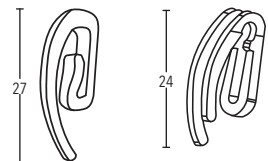
	ARTICLE	FINISH	ARTICLE NO.
	<b>FLAT CURTAIN RING WITH PLASTIC INSERT</b> i.d. 27 mm / o.d. 34 mm  PU = 50	sat. nickel	125820-29
	<b>SEC. RING CLIP</b> for flat curtain ring, with plastic insert art. no. 125820-29  PU = 100	transparent silver	844-00 -29
	<b>FLAT CURTAIN RING WITH EYELET</b> and plastic insert i.d. 27 mm / o.d. 34 mm  PU = 50	sat. nickel	125920-29
	<b>GLIDER WITH SEC. RING CLIP</b> for rails  PU = 100	white grey	739-00 -08
	<b>GLIDER WITH EYELET</b> for rails  PU = 100	white grey	740-00 -08
	<b>HB-SNAP-IN-GLIDER WITH SEC. RING CLIP turnable</b> <b>HB-SNAP-IN-GLIDER WITH EYELET</b> snap-in / snap-out, removable for rails  PU = 100	white white	769-00 770-00
	<b>SNAP-IN-GLIDER WITH SEC. RING CLIP</b> for rails  PU = 100	white grey	742-00 -08
	<b>SNAP-IN-GLIDER WITH EYELET</b> for rails  PU = 100	white grey	743-00 -08
	<b>DRAPERY DIVIDER „ANTI-SLIP“</b> for rails  PU = 100	white grey	799-20-00 -08
	<b>DRAPERY DIVIDER „ANTI-SLIP“</b> with recess masking for rails PU = 100	white grey	799-40-00 -08
	<b>CURTAIN HOOK</b> <b>CURTAIN DOUBLE HOOK</b>  PU = 100	white white	869-00 853-00

Ø 16 mm

# Ø 16 mm Illustrations

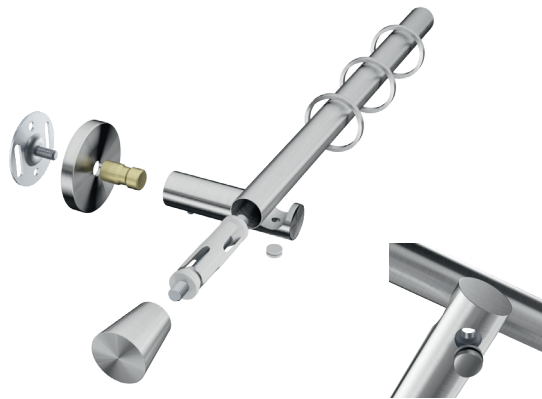

Wall bracket tube installation  
 art. no. 164065 + 164120  
 Please order cover art. no. 165001 separately

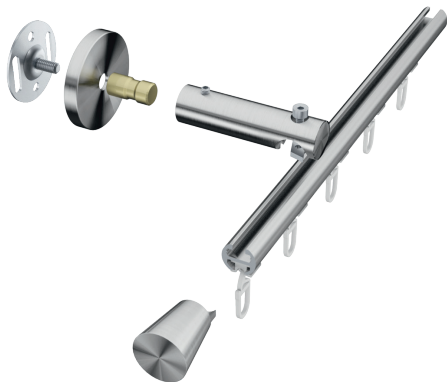
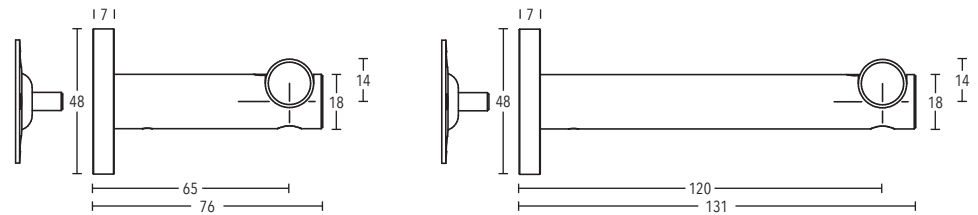

Wall bracket rail installation  
 art. no. 164065 + 164120

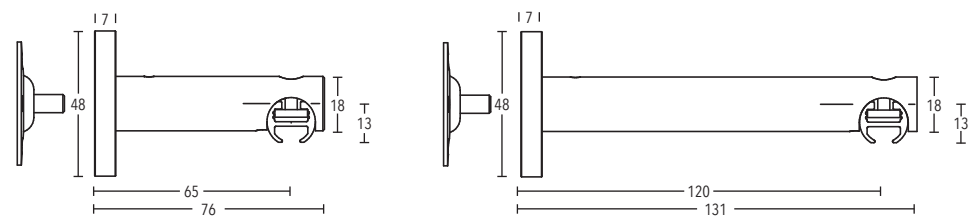

Multi-Wall bracket  
 art. no. 205320-116

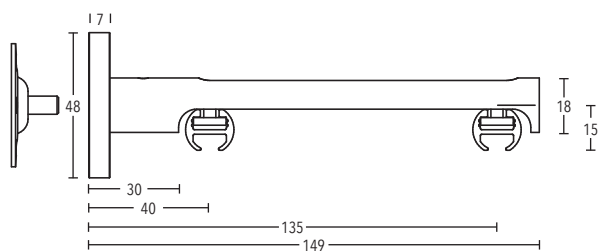

# Ø 16 mm Illustrations

---

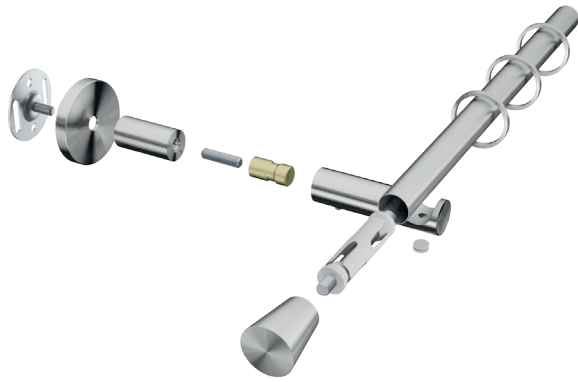

Extension  
art. no. 166035

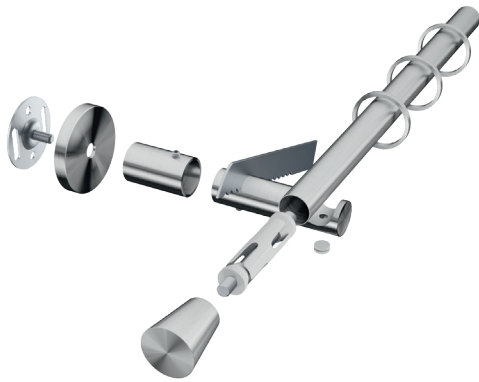

Socket  
art. no. 167002



Ceiling bracket 3 mm  
art. no. 11592

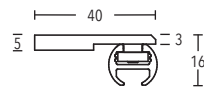

Snap-in Ceiling bracket 5 mm  
art. no. 11693-00

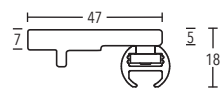



# Ø 16 mm Illustrations



Ceiling bracket 3 mm  
art. no. 11597

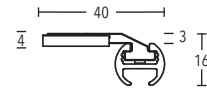

Ceiling bracket 15 mm + 35 mm  
art. no. 164915-116 + 164935-116

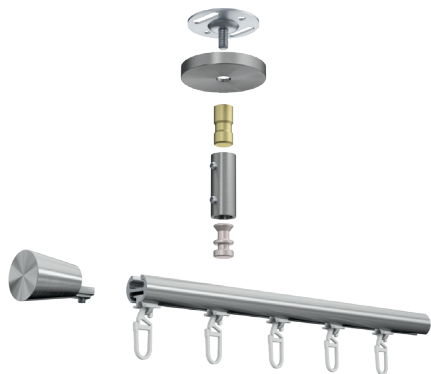
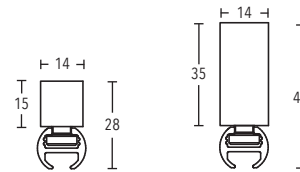

Ceiling bracket 42 mm  
art. no. 164942-116

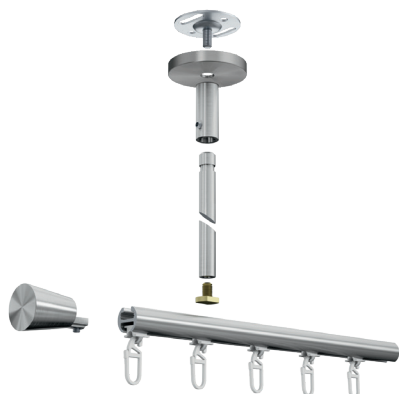
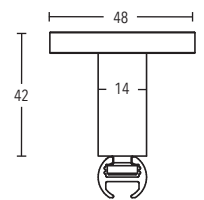

Ceiling bracket 500 mm  
art. no. 164995-116

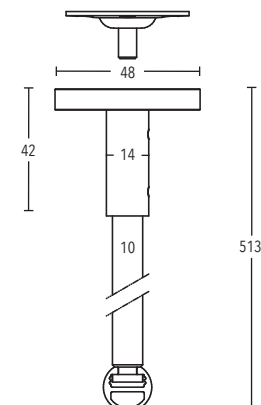

# Ø 16 mm Illustrations

---



Recess bracket  
art. no. 167001

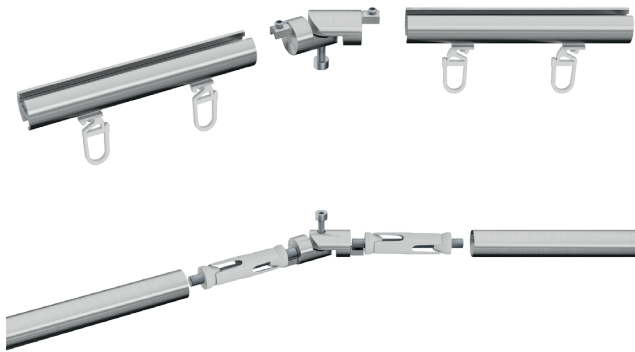
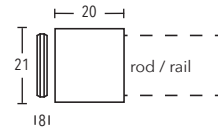

Connector (hinged joint)  
art. no. 122916-116



Rail connector  
art. no. 899-3-00



Rail connector, adjustable  
art. no. 899-3.1-01



Tube connector  
art. no. 83016-000

# BÜSCHE

## VION

Ø 20 mm

silver / beech light

Pole set no. 4-2120-108/221



### Available finishes



-28 white



-108 silver



-109 gold



-116 stainless steel



-132 bronze



-157 matt black



-221 beech light



-222 wild oak



-223 dumson plum



-328 structure white

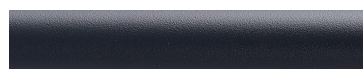

-357 structure black





Ø 20 mm

# Ø 20 mm Decorative Pole Sets

WALL- AND CEILING INSTALLATION / TUBE SINGLE/DOUBLE / COMBIN. BRACKET DOUBLE / RAIL SINGLE/DOUBLE

---

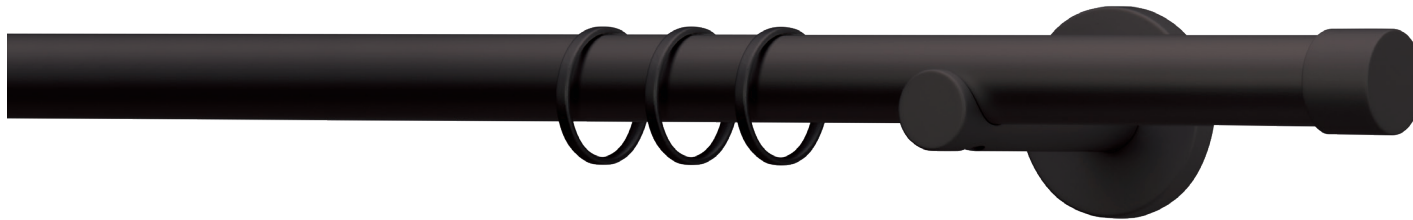

ALBA - matt black - Page 68 - Pole set no. 1-2100-157

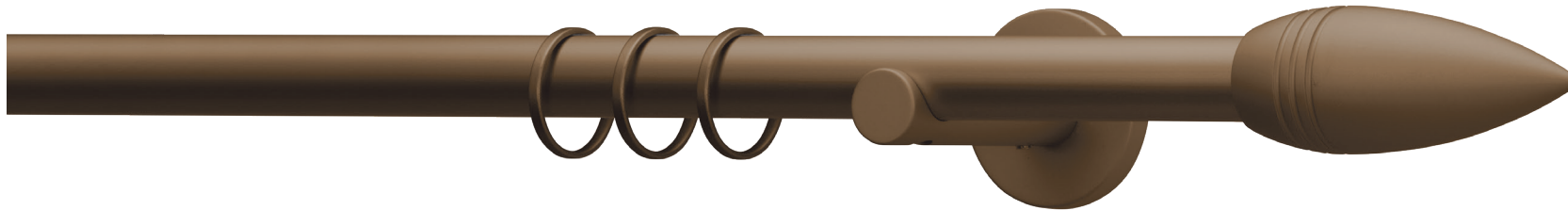

FULA - bronze - Page 70 - Pole set no. 1-2103-132



FALA - stainless steel / wild oak - Page 72 - Pole set no. 4-2120-116/222

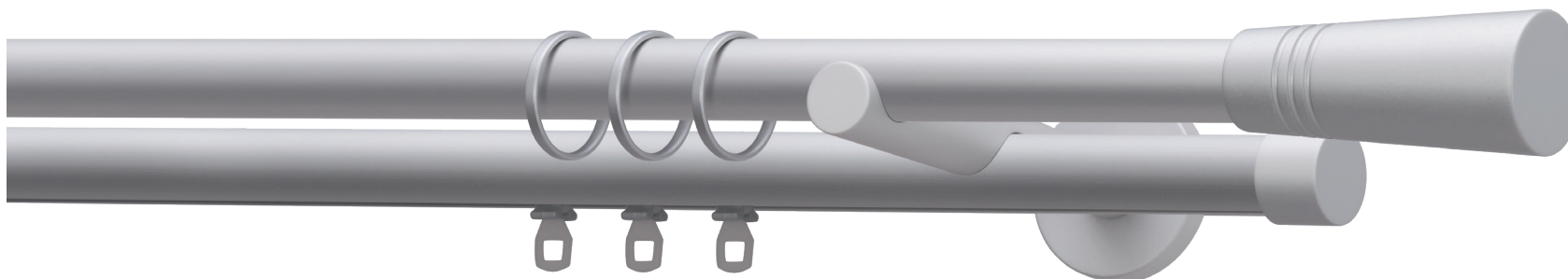

TELO / ALBA - silver - Page 70 - Pole set no. 3-2104-108

**AVAILABLE FINISHES**



LINE - stainless steel - Page 66 - Pole set no. 7-2190-116

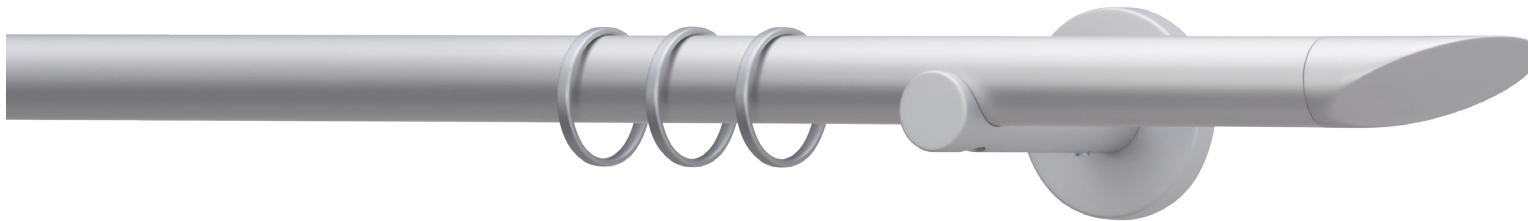

SOLA - silver - Page 70 - Pole set no. 1-2122-108

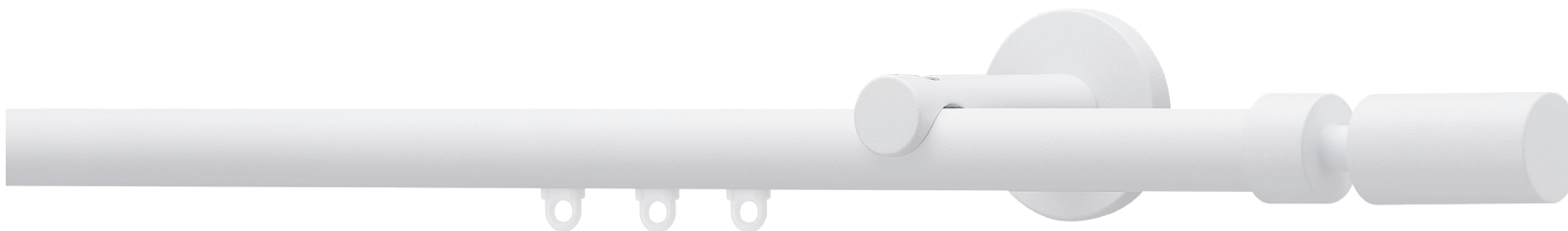

LANA - structure white - Page 70 - Pole set no. 4-2105-328



ELANO / ALBA - structure black - Page 70 - Pole set no. 5-2106-357

Ø 20 mm

# Ø 20 mm Decorative Pole Sets

WALL- AND CEILING INSTALLATION / TUBE SINGLE/DOUBLE / COMBIN. BRACKET DOUBLE / RAIL SINGLE/DOUBLE

---

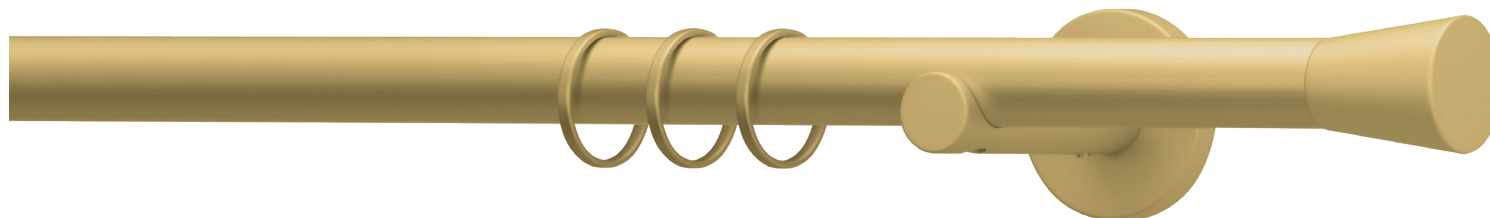

ORIM - gold - Page 70 - Pole set no. 1-2124-109



LINE - stainless steel / beech light - Page 72 - Pole set no. 4-2190-116/221

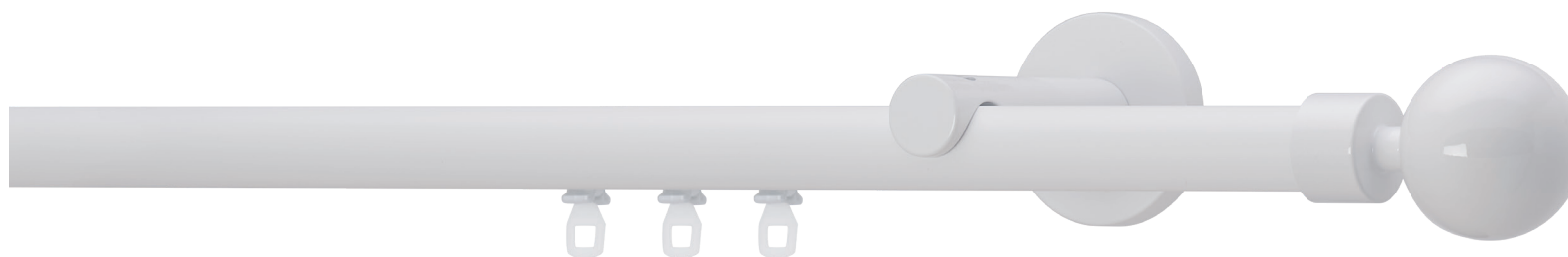

ELANO - white - Page 70 - Pole set no. 4-2106-28

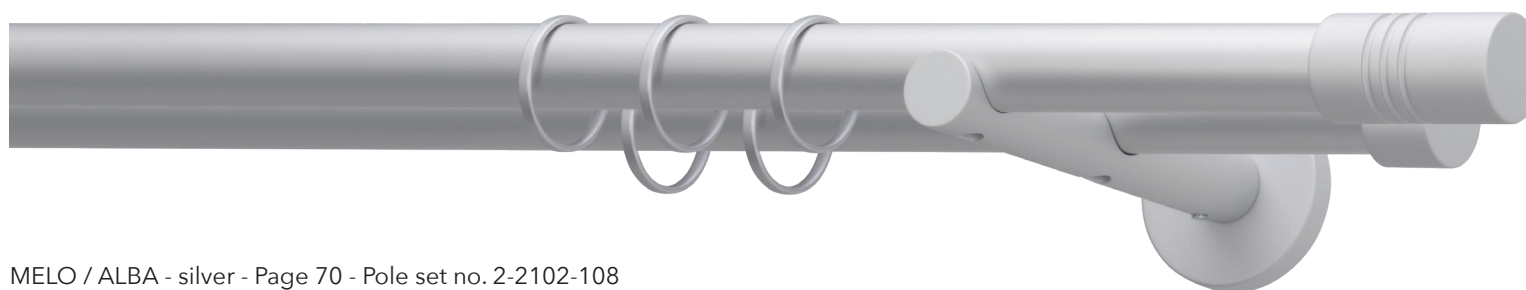

MELO / ALBA - silver - Page 70 - Pole set no. 2-2102-108

**AVAILABLE FINISHES**



LINE - structure black - Page 68 - Pole set no. 4-2190-357

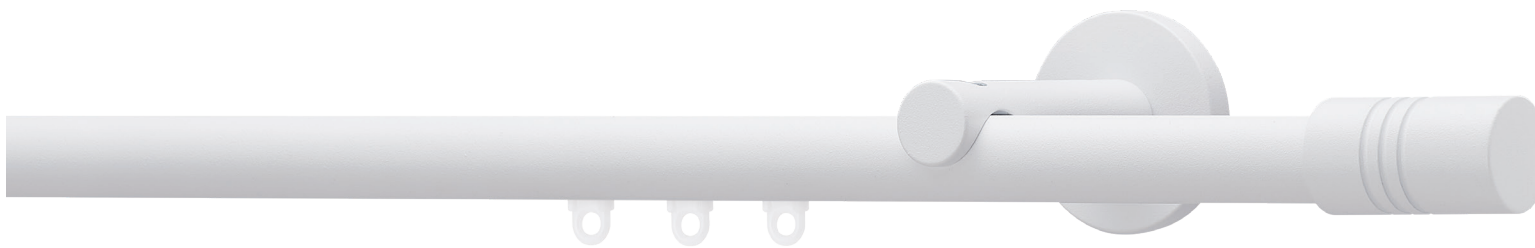

MELO - structure white - Page 70 - Pole set no. 4-2102-328



ORIM - stainless steel / dumson plum - Page 72 - Pole set no. 4-2124-108/223

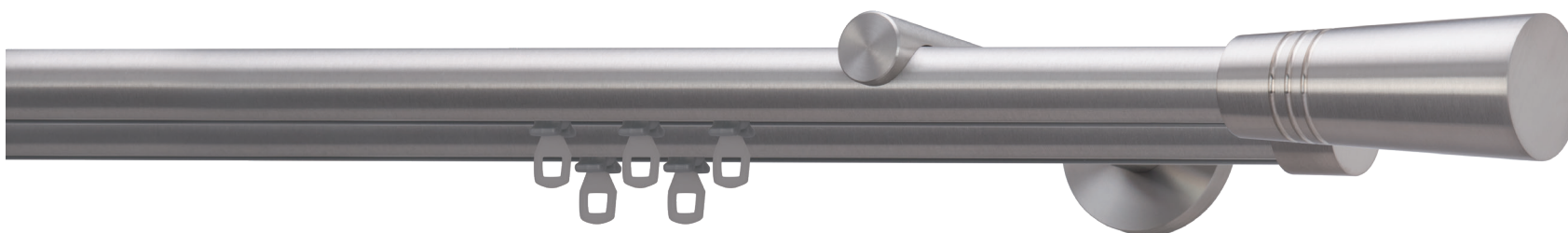

TELO / ALBA - stainless steel - Page 70 - Pole set no. 5-2104-116

Ø 20 mm



# Ø 20 mm Accessories

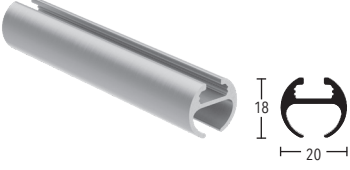
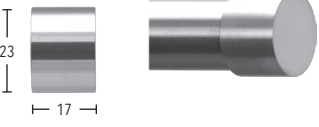
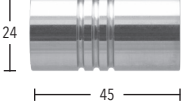
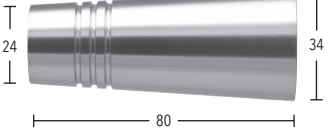

	ARTICLE	FINISH	ARTICLE NO.		
	<b>STAINLESS STEEL-TUBE</b>	stainless steel	800-20-116	fix length (cut to size)	std. length
	<b>ALUMINIUM-TUBE</b> Ø 20 mm standard length 6 m	white silver gold bronze matt black	800-20-28 -108 -109 -132 -157		
	<b>ALUMINIUM-RAIL</b> Ø 20 mm  standard length 6 m	stainless steel white silver gold bronze matt black structure white structure black	808-20-116 -28 -108 -109 -132 -157 -328 -357	fix length (cut to size)	std. length
	<b>WOOD GRAIN EFFECT RAIL</b> Ø 20 mm  standard length 6 m	beech light wild oak dumson plum	808-20-221 -222 -223	fix length (cut to size)	
	<b>END CAP ALBA</b> for Ø 20 mm  PU = 10	stainless steel white silver gold bronze matt black structure white structure black	203000-116 -28 -108 -109 -132 -157 -328 -357		
	<b>END CAP LINE</b> for Ø 20 mm flush finial to fit with tube / rail of equal diameter  PU = 10	stainless steel white silver gold bronze matt black structure white structure black	203100-116 -28 -108 -109 -132 -157 -328 -357		
	<b>FINIAL MELO</b> for Ø 20 mm  PU = 10	stainless steel white silver gold bronze matt black structure white structure black	203013-116 -28 -108 -109 -132 -157 -328 -357		
	<b>FINIAL FULA</b> for Ø 20 mm  PU = 10	stainless steel silver gold bronze matt black	203014-116 -108 -109 -132 -157		
	<b>FINIAL TELO</b> for Ø 20 mm  PU = 10	stainless steel silver gold bronze matt black	203015-116 -108 -109 -132 -157		
	<b>FINIAL FALA</b> for Ø 20 mm flush finial to fit with tube / rail of equal diameter  PU = 10	stainless steel white silver matt black structure white structure black	203030-116 -28 -108 -157 -328 -357		

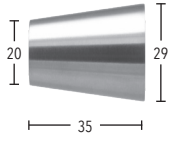
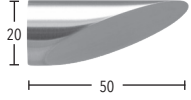
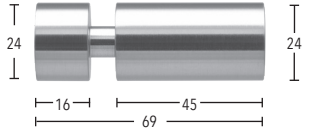
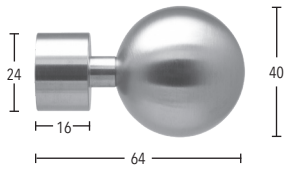
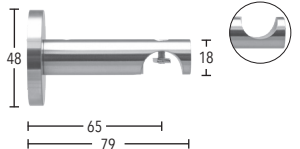
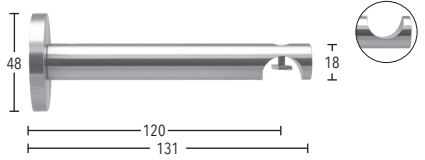
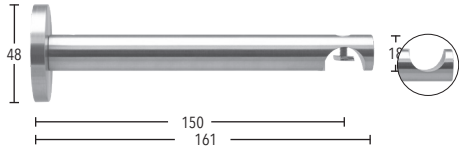
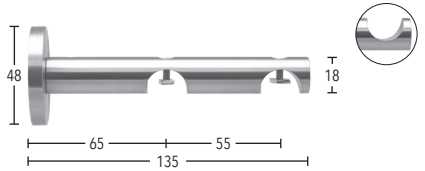
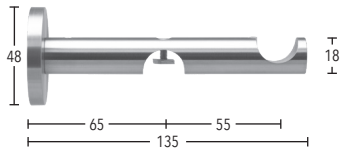
# Ø 20 mm Accessories

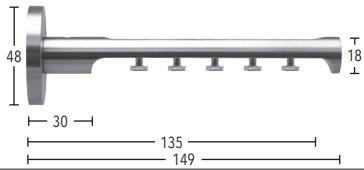

	ARTICLE	FINISH	ARTICLE NO.
	<b>FINIAL ORIM</b> for Ø 20 mm flush finial to fit with tube / rail of equal diameter  PU = 10	stainless steel white silver gold bronze matt black structure white structure black	203031-116 -28 -108 -109 -132 -157 -328 -357
	<b>FINIAL SOLA</b> for Ø 20 mm flush finial to fit with tube / rail of equal diameter  PU = 10	stainless steel white silver matt black	203033-116 -28 -108 -157
	<b>FINIAL LANA</b> for Ø 20 mm  PU = 10	stainless steel white silver matt black structure white structure black	203020-116 -28 -108 -157 -328 -357
	<b>FINIAL ELANO</b> for Ø 20 mm  PU = 10	stainless steel white silver gold bronze matt black structure white structure black	203021-116 -28 -108 -109 -132 -157 -328 -357
	<b>WALL BRACKET ALUX (System 1- + 4-)</b> single, wall ext. 65 mm without cover (art. no. 165001) for Ø 20 mm tubes / rails  PU = 10	stainless steel white silver gold bronze matt black structure white structure black	204065-116 -28 -108 -109 -132 -157 -328 -357
	<b>WALL BRACKET ALUX</b> single, wall ext. 120 mm without cover (art. no. 165001) for Ø 20 mm tubes / rails  PU = 10	stainless steel white silver gold bronze matt black structure white structure black	204120-116 -28 -108 -109 -132 -157 -328 -357
	<b>WALL BRACKET ALUX</b> single, wall ext. 150 mm without cover (art. no. 165001) for Ø 20 mm tubes / rails  PU = 10	stainless steel silver gold bronze matt black	214150-116 -108 -109 -132 -157
	<b>WALL BRACKET ALUX (System 2- + 5-)</b> double, wall ext. 65/120 mm without cover (art. no. 165001) for Ø 20 mm tubes/rails  PU = 10	stainless steel white silver gold bronze matt black structure white structure black	205120-116 -28 -108 -109 -132 -157 -328 -357
	<b>KOMBI-WALL BRACKET ALUX (System 3-)</b> double, wall ext. 65/120 mm 1. track tube / 2. track rail for Ø 20 mm tubes/rails  PU = 10	stainless steel white silver gold bronze matt black	205220-116 -28 -108 -109 -132 -157

Ø 20 mm

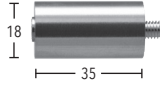
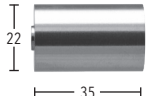
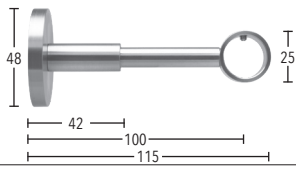
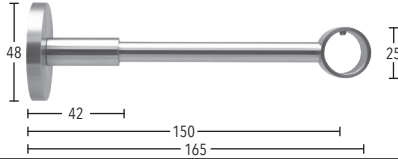
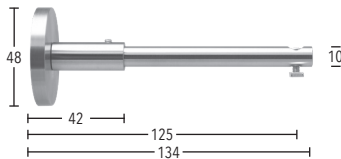
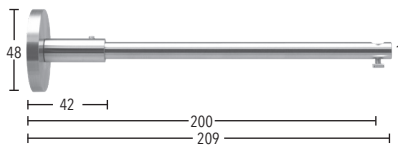
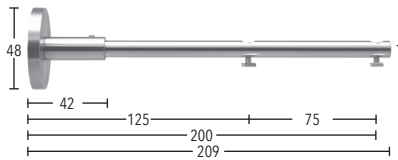
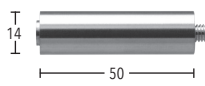



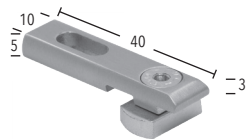
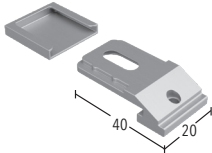
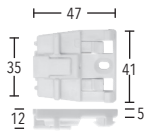

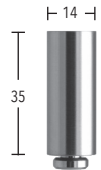
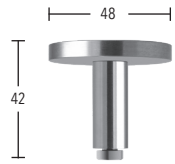
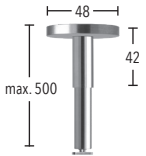
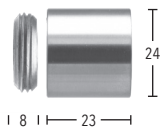
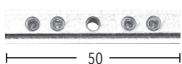
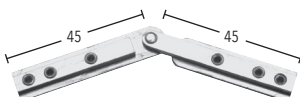
# Ø 20 mm Accessories

	ARTICLE	FINISH	ARTICLE NO.
	<b>MULTI-WALL BRACKET ALUX</b> for mounting of 1-5 rails wall ext. 40-135 mm for Ø 20 mm  PU = 10	stainless steel white silver matt black	205320-116 -28 -108 -157
	<b>BORE HOLE INSERT FOR ALL BRACKETES ALUX</b> material stainless steel resp. aluminium to cover bore holes when using the bracket as tube bracket  PU = 10	stainless steel white silver gold bronze matt black	165001-116 -28 -108 -109 -132 -157
	<b>EXTENSION</b> length 35 mm for all brackets »ALUX«  PU = 10	stainless steel white silver gold bronze matt black structure white structure black	166035-116 -28 -108 -109 -132 -157 -328 -357
	<b>SOCKET</b> for cut brackets »ALUX«  PU = 10	stainless steel	167002-116
	<b>WALL BRACKET GEO</b> single, wall ext. 100 mm, can be cut for Ø 20 mm tubes  PU = 10	stainless steel matt black	204100-116 -157
	<b>WALL BRACKET GEO</b> single, wall ext. 150 mm, can be cut for Ø 20 mm tubes  PU = 10	stainless steel matt black	204150-116 -157
	<b>WALL BRACKET GEO</b> single, wall ext. 125 mm, can be cut for Ø 20 mm rails  PU = 6	stainless steel white bronze matt black	284425-116 -28 -132 -157
	<b>WALL BRACKET GEO</b> single, wall ext. 200 mm, can be cut for Ø 20 mm rails  PU = 6	stainless steel white bronze matt black	284500-116 -28 -132 -157
	<b>WALL BRACKET GEO</b> double, wall ext. 125 / 200 mm, can be cut for Ø 20 mm rails  PU = 6	stainless steel matt black	285500-116 -157
	<b>EXTENSION</b> length 50 mm for all wall brackets "GEO"  PU = 10	stainless steel white bronze matt black	166050-116 -28 -132 -157

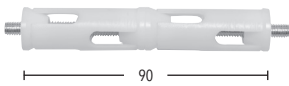
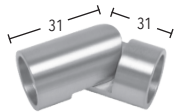
# Ø 20 mm Accessories

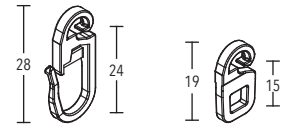
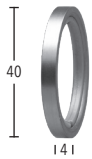
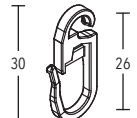
	ARTICLE	FINISH	ARTICLE NO.
	<b>CEILING BRACKET 3 mm (System 6-)</b> single, ceiling ext. 21 mm for rails  PU = 10	silver white black	11592-00 -28 -157
	<b>CEILING BRACKET 3 mm (System 11-)</b> including borehole cover single, ceiling ext. 21 mm for rails  PU = 10	silver white black	11597-00 -28 -157
	<b>SNAP-IN CEILING BRACKET 5 mm (System 10-)</b> single, ceiling ext. 23 mm Material: plastic for rails  PU = 10	white	11693-00
	<b>CEILING BRACKET 15 mm (System 7-)</b> single, ceiling ext. 33 mm for rails  PU = 10	stainless steel white silver gold bronze matt black structure white structure black	164915-116 -28 -108 -109 -132 -157 -328 -357
	<b>CEILING BRACKET 35 mm (System 8-)</b> single, ceiling ext. 53 mm for rails  PU = 10	stainless steel white silver gold bronze matt black structure white structure black	164935-116 -28 -108 -109 -132 -157 -328 -357
	<b>CEILING BRACKET 42 mm</b> single, ceiling ext. 60 mm with 3-hole mounting plate for rails  PU = 10	stainless steel white silver gold bronze matt black structure white structure black	164942-116 -28 -108 -109 -132 -157 -328 -357
	<b>CEILING BRACKET 500 mm</b> single, ceiling ext. 60-518 mm (can be cut) with 3-hole mounting plate for rails  PU = 1	stainless steel white silver gold matt black structure white structure black	164995-116 -28 -108 -109 -157 -328 -357
	<b>RECESS BRACKET</b> for Ø 20 mm  PU = 10	stainless steel white silver gold bronze matt black structure white structure black	207001-116 -28 -108 -109 -132 -157 -328 -357
	<b>RAIL CONNECTOR</b> for rails PU = 10	silver	899-3-00
	<b>RAIL CONNECTOR</b> adjustable for rails PU = 10 »Mitring see info page 28«	silver	899-3.1-01

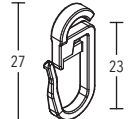
# Ø 20 mm Accessories

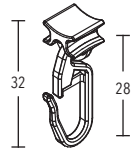
	ARTICLE	FINISH	ARTICLE NO.
	<b>TUBE CONNECTOR</b> for Ø 20 mm tubes  PU = 10	white	83020-000
	<b>CONNECTOR (HINGED JOINT)</b> for Ø 20 mm tubes and rails  PU = 1	stainless steel matt black	122920-116 -157
	<b>FLAT CURTAIN RING</b> i.d. 28 mm, o.d. 32 mm  PU = 100	stainless steel silver gold bronze matt black	225720-116 -108 -109 -132 -57
	<b>SEC. RING CLIP</b> <b>SEC. RING CLIP WITH EYELET</b> for flat curtain ring art. no. 225720  PU = 100	transparent transparent	718-4-00 722-4-00
	<b>FLAT CURTAIN RING WITH PLASTIC INSERT</b> i.d. 32 mm, o.d. 40 mm  PU = 100	white	202040-28
	<b>SEC. RING CLIP</b> for flat curtain ring art. no. 202040-28  PU = 100	white	818-6-28
	<b>FLAT CURTAIN RING WITH PLASTIC INSERT</b> i.d. 27 mm / o.d. 34 mm  PU = 50	sat. aluminium sat. brass sat. nickel matt black antique brass matt	125820-08 -24 -29 -57 -70
	<b>SEC. RING CLIP</b> for flat curtain rings with plastic insert Article No. 125820  PU = 100	transparent gold silver black brown	844-00 -24 -29 -57 -70
	<b>FLAT CURTAIN RING WITH EYELET</b> and plastic insert i.d. 27 mm / o.d. 34 mm  PU = 50	sat. aluminium sat. brass sat. nickel matt black antique brass matt	125920-08 -24 -29 -57 -70
	<b>GLIDER WITH SEC. RING CLIP</b> for rails  PU = 100	white grey black	739-00 -08 -57

# Ø 20 mm Accessories

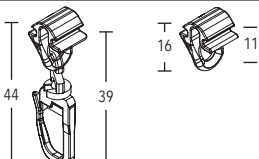
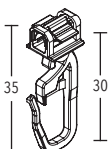
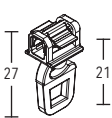
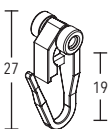
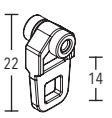
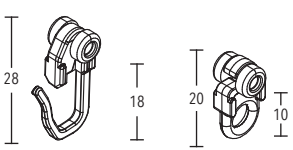
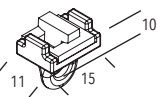
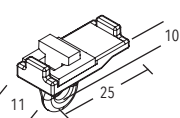
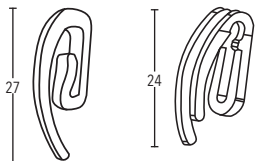
	ARTICLE	FINISH	ARTICLE NO.
	<b>GLIDER WITH EYELET</b> for rails  PU = 100	white grey black	740-00 -08 -57
	<b>HB-SNAP-IN-GLIDER WITH SEC. RING CLIP turnable</b> <b>HB-SNAP-IN-GLIDER WITH EYELET</b> snap-in / snap-out, removable for rails  PU = 100	white white	769-00 770-00
	<b>SNAP-IN-GLIDER WITH SEC. RING CLIP</b> for rails  PU = 100	white grey black	742-00 -08 -57
	<b>SNAP-IN-GLIDER WITH EYELET</b> for rails  PU = 100	white grey black	743-00 -08 -57
	<b>ROLLER GLIDER WITH SEC. RING CLIP</b> for rails  PU = 100	white grey black	741-00 -08 -57
	<b>ROLLER GLIDER WITH EYELET</b> for rails  PU = 100	white grey black	748-00 -08 -57
	<b>ROLLER GLIDER WITH SEC. RING CLIP</b> <b>ROLLER GLIDER WITH EYELET</b> for rails  PU = 100	white white	752-00 751-00
	<b>DRAPERY DIVIDER "ANTI-SLIP"</b> for rails  PU = 100	white grey black	799-20-00 -08 -57
	<b>DRAPERY DIVIDER "ANTI-SLIP"</b> with recess masking for rails  PU = 100	white grey black	799-40-00 -08 -57
	<b>CURTAIN HOOK</b> <b>CURTAIN DOUBLE HOOK</b>  PU = 100	white white	869-00 853-00

# Ø 20 mm Illustrations

---

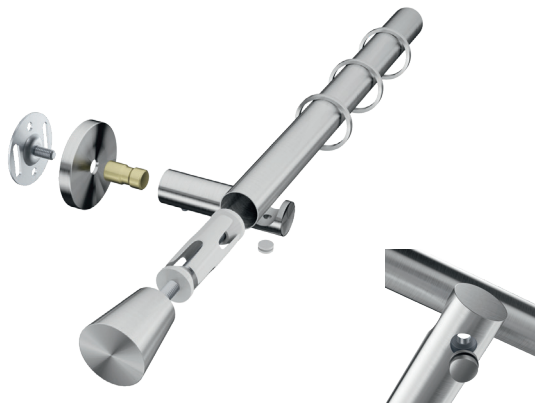

Wall bracket tube installation  
art. no. 204065 + 204120 + 214150  
Please order cover art. no. 165001 separately

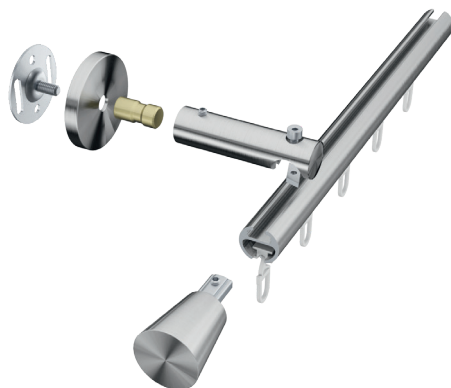
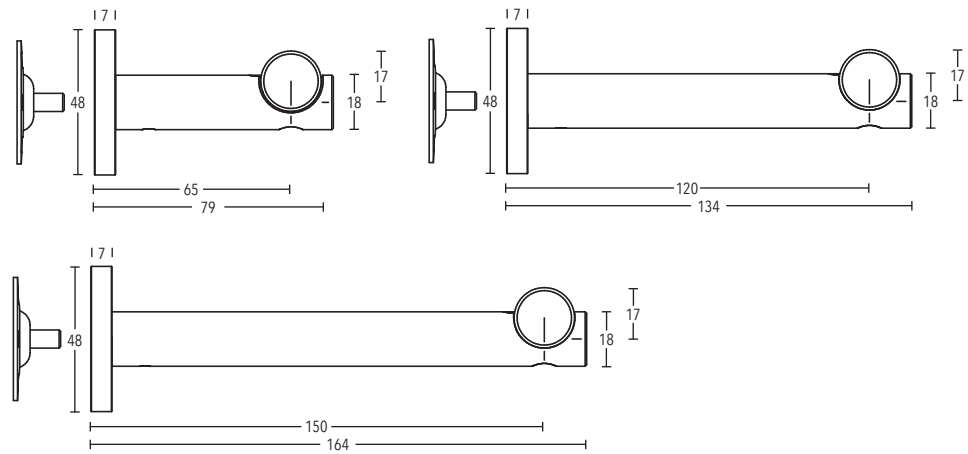

Wall bracket rail installation  
art. no. 204065 + 204120 + 214150

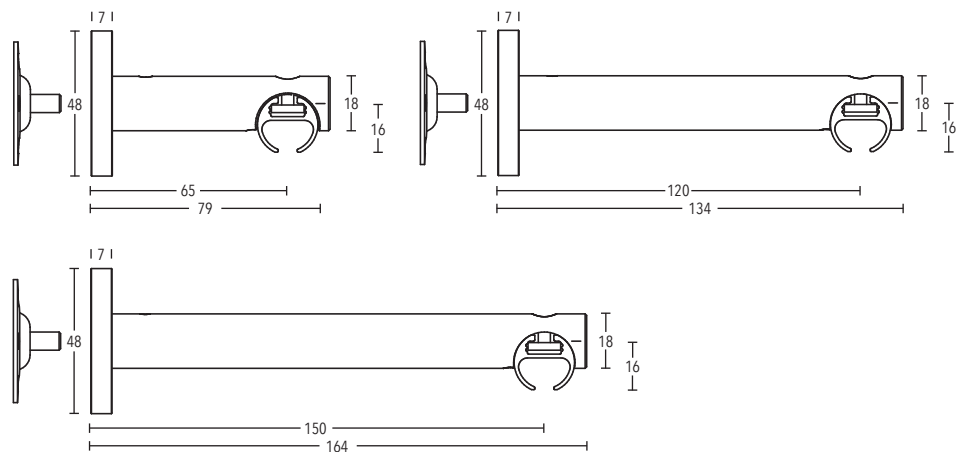

# Ø 20 mm Illustrations

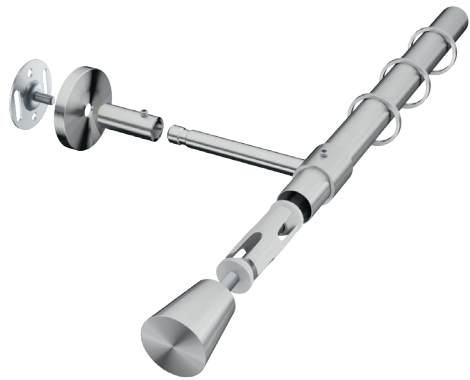

Wall bracket tube installation  
art. no. 204100 + 204150

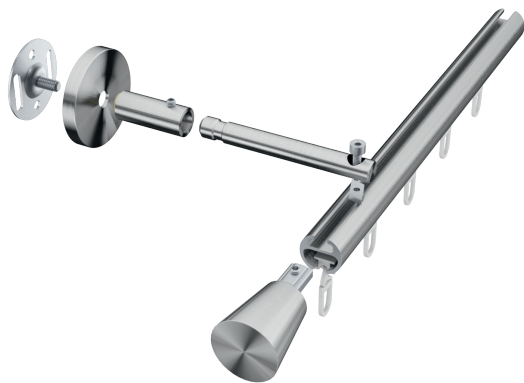
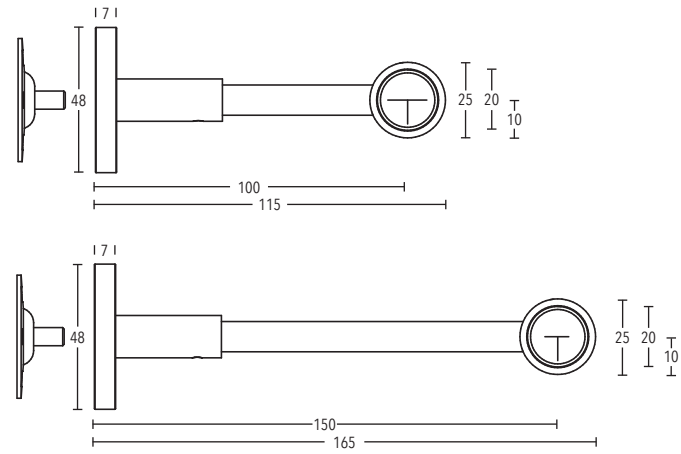

Wall bracket rail installation  
art. no. 284425 + 284500

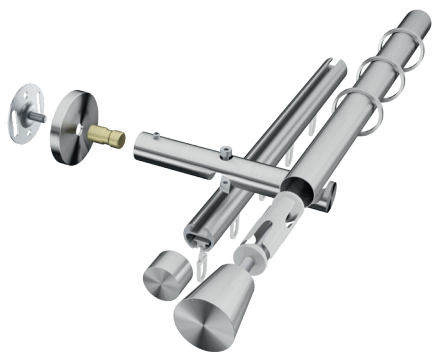
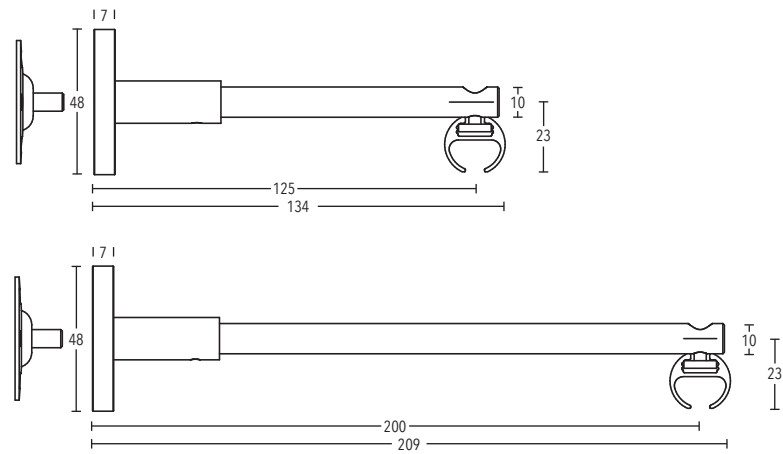

Combination-bracket  
art. no. 205220

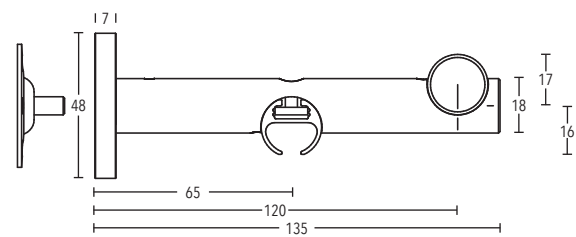



# Ø 20 mm Illustrations

---

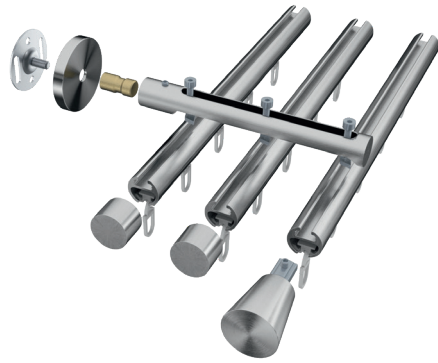

Multi-Wall bracket  
art. no. 205320

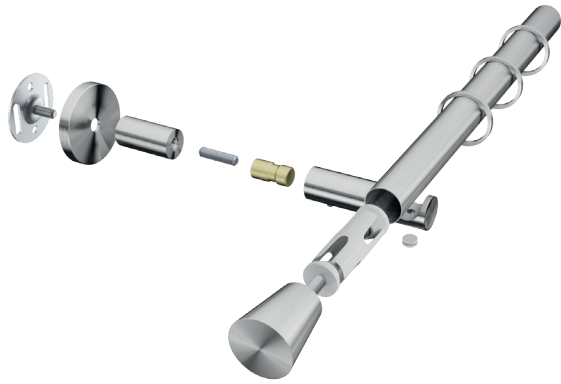
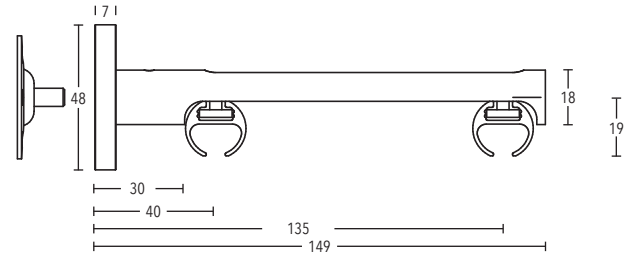

Extension  
art. no. 166035

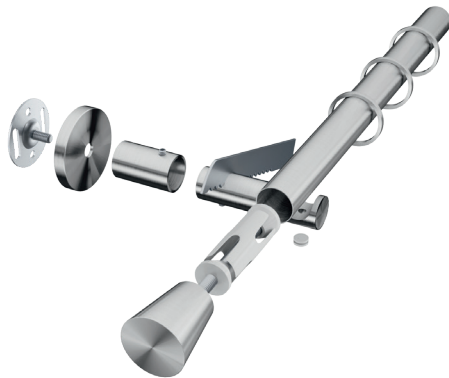

Socket  
art. no. 167002



Ceiling bracket 3 mm  
art. no. 11592

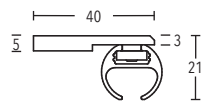

# Ø 20 mm Illustrations

---



Snap-in Ceiling bracket 5 mm  
art. no. 11693-00

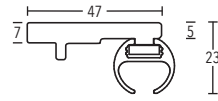

Ceiling bracket 3 mm  
art. no. 11597

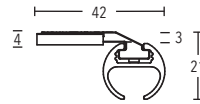

Ceiling bracket 15 mm  
art. no. 164915

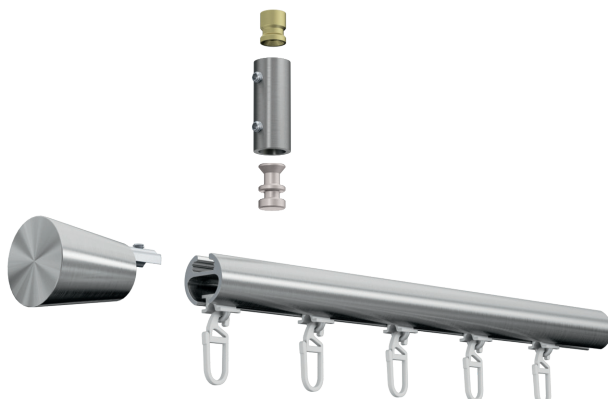
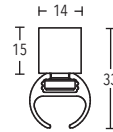

Ceiling bracket 35 mm  
art. no. 164935

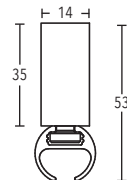

Ø 20 mm

# Ø 20 mm Illustrations

---

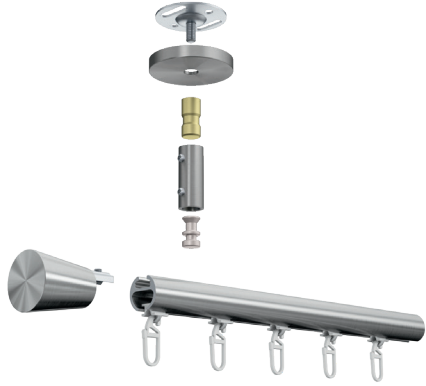

Ceiling bracket 42 mm  
art. no. 164942

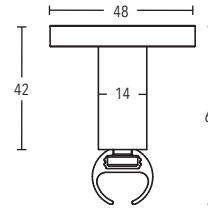

Ceiling bracket 500 mm  
art. no. 164995

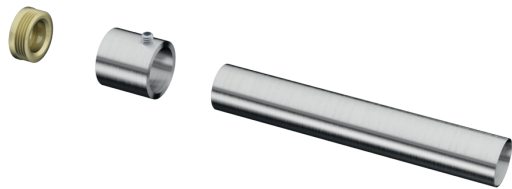
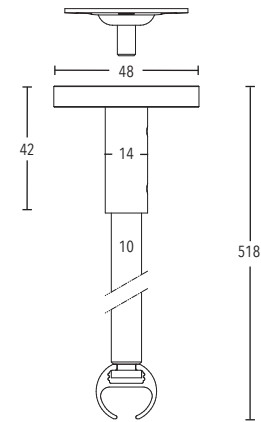

Recess bracket  
art. no. 207001

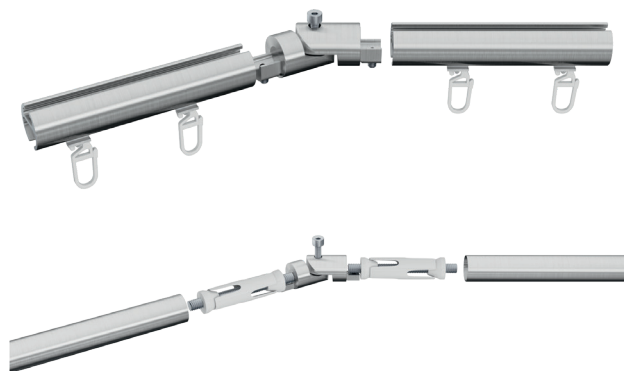
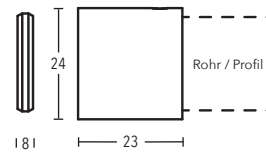

Connector (hinged joint)  
art. no. 122920

## Ø 20 mm Illustrations

---



Rail connector  
art. no. 899-3-00



Rail connector, adjustable  
art. no. 899-3.1-01

---



Tube connector  
art. no. 83020-000

---

Ø 20 mm

# BÜSCHE

## VION

Ø 24 mm

---

matt black

Pole set no. 4-2503-157

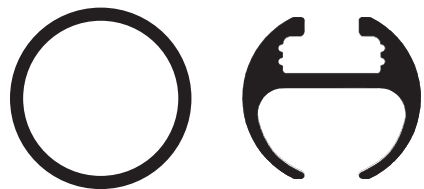

### Available finishes



-108 silver



-116 stainless steel



-132 bronze



-157 matt black





Ø 24 mm

# Ø 24 mm Decorative Pole Sets

WALL- AND CEILING INSTALLATION / TUBE SINGLE/DOUBLE / RAIL SINGLE/DOUBLE

---



LINE - matt black - Page 90 - Pole set no. 7-2590-157

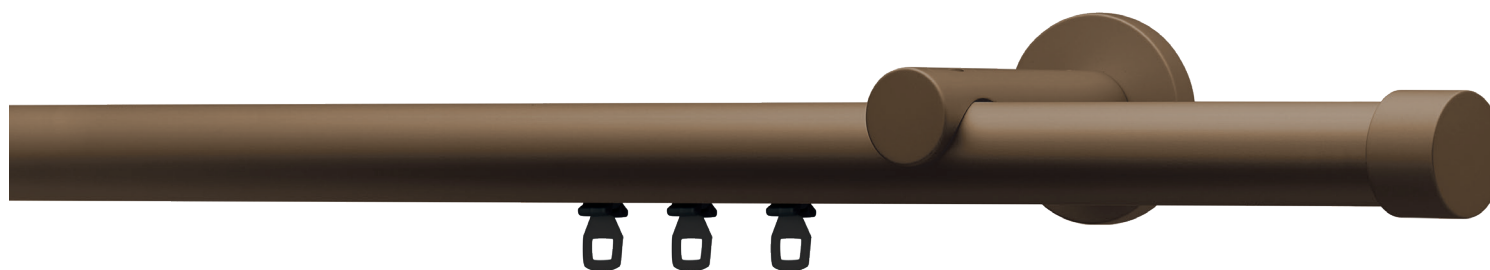

ALBA - bronze - Page 92 - Pole set no. 4-2500-132

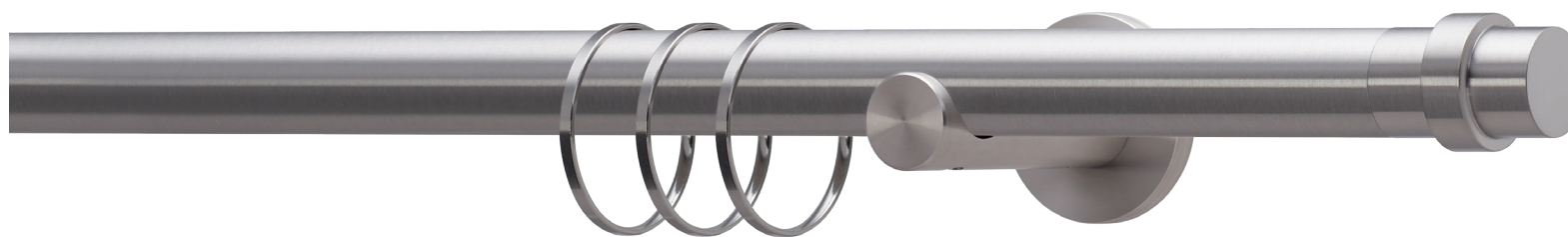

PISTO - stainless steel - Page 94 - Pole set no. 1-2501-116

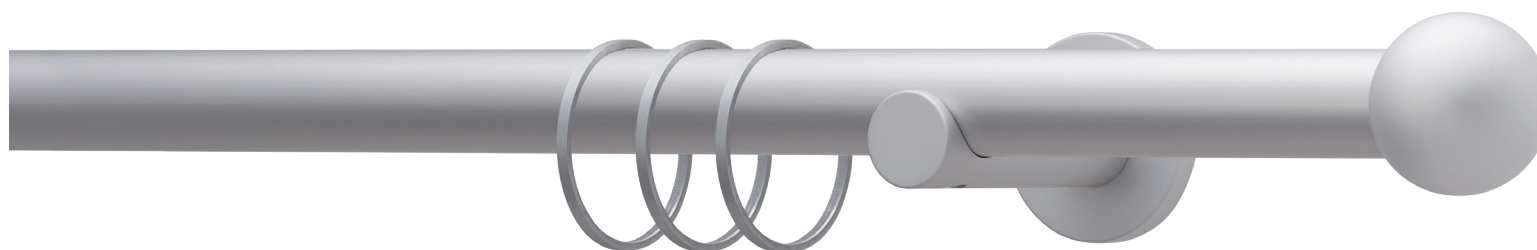

TERA - silver - Page 94 - Pole set no. 1-2502-108

**AVAILABLE FINISHES**



-108 silver



-116 stainless steel



-132 bronze



-157 matt black

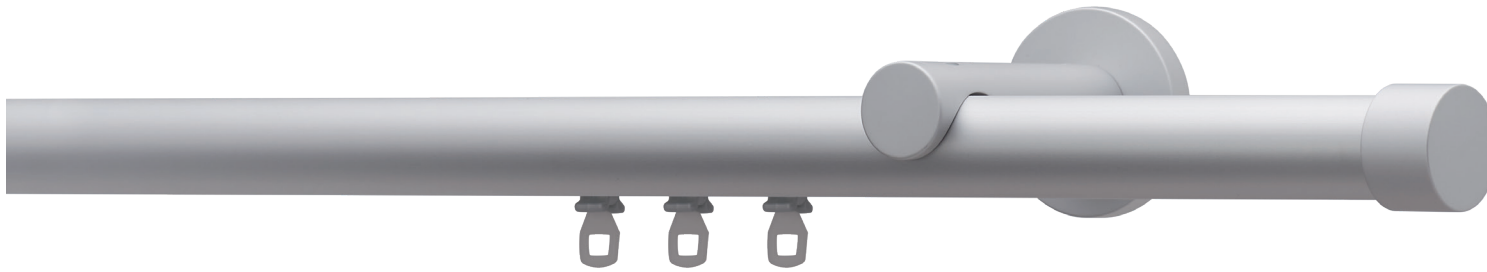

ALBA - silver - Page 92 - Pole set no. 4-2500-108



RIBO - stainless steel - Page 94 - Pole set no. 1-2503-116

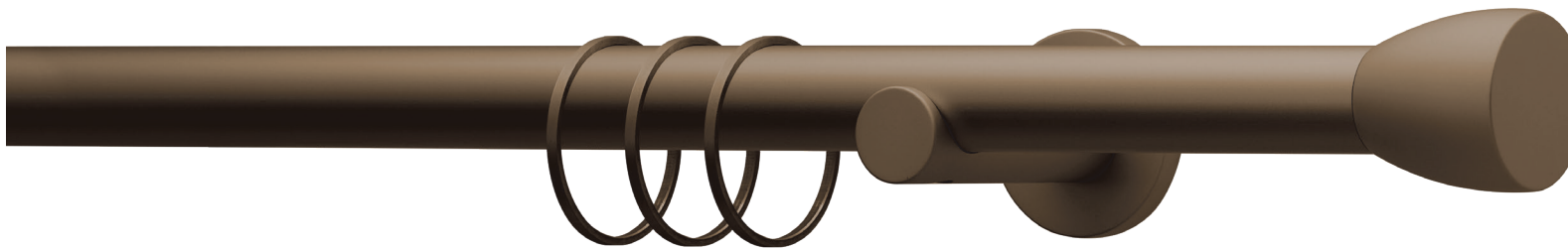

TARO - bronze - Page 94 - Pole set no. 1-2504-132



LINE - matt black - Page 92 - Pole set no. 4-2590-157



Ø 24 mm

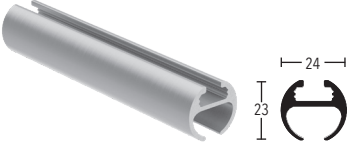
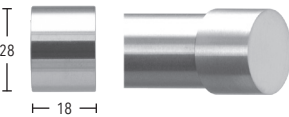
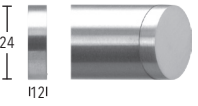
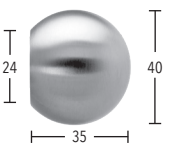
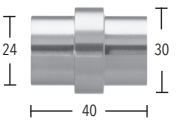
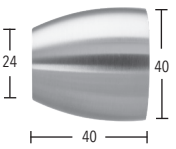
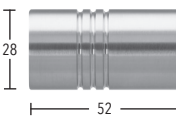
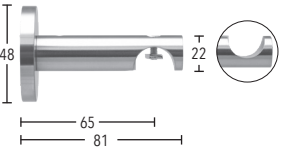
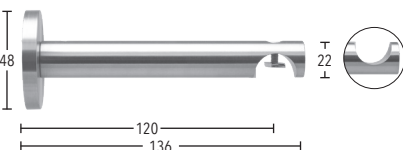

# Ø 24 mm Accessories

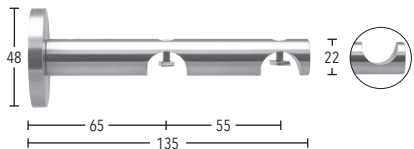

	ARTICLE	FINISH	ARTICLE NO.		
	<b>STAINLESS STEEL-TUBE</b>	stainless steel	800-24-116	fix length (cut to size)	std. length
	<b>ALUMINIUM-TUBE</b> Ø 24 mm Price € per metre standard length 6 m	silver bronze matt black	-108 -132 -157		
	<b>ALUMINIUM-RAIL</b> Ø 24 mm Price € per metre standard length 6 m	stainless steel silver bronze matt black	808-24-116 -108 -132 -157	fix length (cut to size)	std. length
	<b>END CAP ALBA</b> for Ø 24 mm PU = 10	stainless steel silver bronze matt black	243000-116 -108 -132 -157		
	<b>END CAP LINE</b> for Ø 24 mm flush finial to fit with tube / rail of equal diameter PU = 10	stainless steel silver bronze matt black	243100-116 -108 -132 -157		
	<b>FINIAL TERA</b> for Ø 24 mm PU = 10	stainless steel silver bronze matt black	243010-116 -108 -132 -157		
	<b>FINIAL PISTO</b> for Ø 24 mm flush finial to fit with tube / rail of equal diameter PU = 10	stainless steel silver bronze matt black	243011-116 -108 -132 -157		
	<b>FINIAL TARO</b> for Ø 24 mm flush finial to fit with tube / rail of equal diameter PU = 10	stainless steel silver bronze matt black	243012-116 -108 -132 -157		
	<b>FINIAL RIBO</b> for Ø 24 mm PU = 10	stainless steel silver bronze matt black	243013-116 -108 -132 -157		
	<b>WALL BRACKET ALUX (System 1- + 4-)</b> single, wall ext. 65 mm without cover (art. no. 165001) for Ø 24 mm tubes / rails PU = 10	stainless steel silver bronze matt black	244065-116 -108 -132 -157		
	<b>WALL BRACKET ALUX</b> single, wall ext. 120 mm without cover (art. no. 165001) for Ø 24 mm tubes / rails PU = 10	stainless steel silver bronze matt black	244120-116 -108 -132 -157		

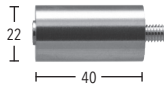
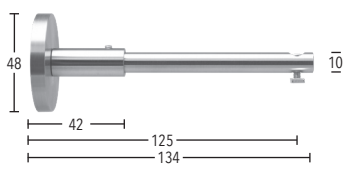
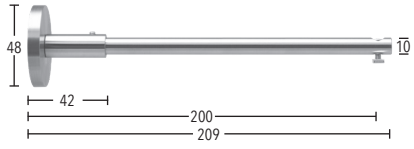
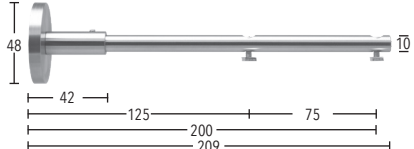
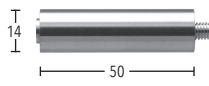
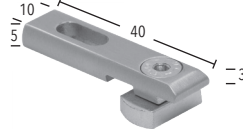
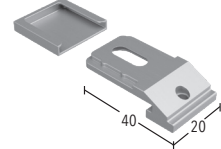
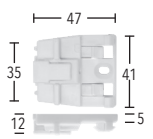
# Ø 24 mm Accessories



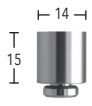
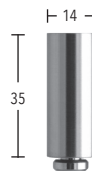

	ARTICLE	FINISH	ARTICLE NO.
	<b>WALL BRACKET ALUX (System 2- + 5-)</b> double, wall ext. 65/120 mm without cover (art. no. 165001) for Ø 24 mm tubes / rails  PU = 10	stainless steel silver bronze matt black	245120-116 -108 -132 -157
	<b>BORE HOLE INSERT FOR ALL BRACKETES ALUX</b> material stainless steel resp. aluminium to cover bore holes when using the bracket as tube bracket  PU = 10	stainless steel silver bronze matt black	165001-116 -108 -132 -157
	<b>EXTENSION</b> length 40 mm for all brackets »ALUX«  PU = 10	stainless steel silver bronze matt black	286040-116 -108 -132 -157
	<b>WALL BRACKET GEO</b> single, wall ext. 125 mm, can be cut for Ø 24 mm rails  PU = 6	stainless steel bronze matt black	284425-116 -132 -157
	<b>WALL BRACKET GEO</b> single, wall ext. 200 mm, can be cut for Ø 24 mm rails  PU = 6	stainless steel bronze matt black	284500-116 -132 -157
	<b>WALL BRACKET GEO</b> double, wall ext. 125 / 200 mm, can be cut for Ø 24 mm rails  PU = 6	stainless steel matt black	285500-116 -157
	<b>EXTENSION</b> length 50 mm for all wall brackets „GEO“  PU = 10	stainless steel bronze black	166050-116 -132 -157
	<b>CEILING BRACKET 3 mm (System 6-)</b> single, ceiling ext. 26 mm for rails  PU = 10	silver white black	11592-00 -28 -157
	<b>CEILING BRACKET 3 mm (System 11-)</b> including borehole cover single, ceiling ext. 26 mm for rails  PU = 10	silver white black	11597-00 -28 -157
	<b>SNAP-IN CEILING BRACKET (System 10-)</b> single, ceiling ext. 28 mm Material: plastic for rails  PU = 10	white	11693-00

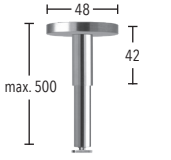
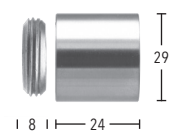
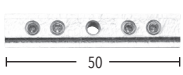
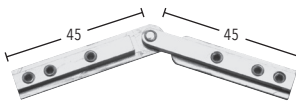
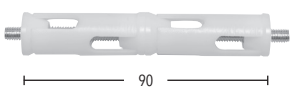
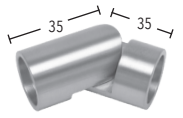
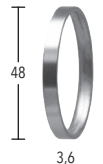
Ø 24 mm

# Ø 24 mm Accessories

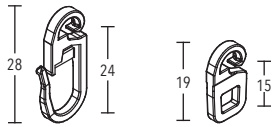
	ARTICLE	FINISH	ARTICLE NO.
	<b>CEILING BRACKET 15 mm (System 7-)</b> single, ceiling ext. 38 mm for rails  PU = 10	stainless steel silver bronze matt black	164915-116 -108 -132 -157
	<b>CEILING BRACKET 35 mm (System 8-)</b> single, ceiling ext. 58 mm for rails  PU = 10	stainless steel silver bronze matt black	164935-116 -108 -132 -157
	<b>CEILING BRACKET 42 mm</b> single, ceiling ext. 65 mm with 3-hole mounting plate for rails  PU = 10	stainless steel silver bronze matt black	164942-116 -108 -132 -157
	<b>CEILING BRACKET 500 mm</b> single, ceiling ext. 65-523 mm ( can be cut ) with 3-hole mounting plate for rails  PU = 1	stainless steel silver matt black	164995-116 -108 -157
	<b>RECESS BRACKET</b> for Ø 24 mm  PU = 10	stainless steel silver bronze matt black	247001-116 -108 -132 -157
	<b>RAIL CONNECTOR</b> for rails  PU = 10	silver	899-3-00
	<b>RAIL CONNECTOR</b> adjustable for rails  PU = 10 »Mitring see info page 28«	silver	899-3.1-01
	<b>TUBE CONNECTOR</b> for Ø 24 mm tubes  PU = 10	white	83024-000
	<b>CONNECTOR (HINGED JOINT)</b> for Ø 24 mm tubes and rails  PU = 1	stainless steel matt black	122924-116 -157
	<b>FLAT CURTAIN RING</b> i.d. 44 mm, o.d. 48 mm  PU = 100	stainless steel silver bronze matt black	225728-116 -108 -132 -57

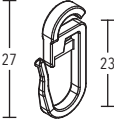
# Ø 24 mm Accessories

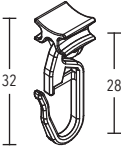
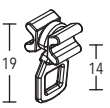
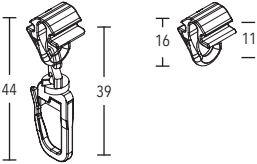
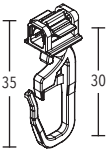
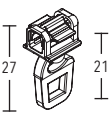
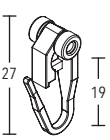
	ARTICLE	FINISH	ARTICLE NO.
	<b>SEC. RING CLIP</b> <b>SEC. RING CLIP WITH EYELET</b> for flat curtain rings art no. 225728  PU = 100	transparent transparent	718-4-00 722-4-00
	<b>FLAT CURTAIN RING WITH PLASTIC INSERT</b> i.d. 39 mm / o.d. 48 mm  PU = 50	sat. nickel matt black antique brass matt	125830-29 -57 -70
	<b>SEC. RING CLIP</b> for flat curtain rings with plastic insert art no. 125830  PU = 100	transparent silver black brown	844-00 -29 -57 -70
	<b>FLAT CURTAIN RING WITH EYELET</b> and plastic insert i.d. 39 mm / o.d. 48 mm  PU = 50	sat. nickel matt black antique brass matt	125930-29 -57 -70
	<b>GLIDER WITH SEC. RING CLIP</b> for rails  PU = 100	white grey black	739-00 -08 -57
	<b>GLIDER WITH EYELET</b> for rails  PU = 100	white grey black	740-00 -08 -57
	<b>HB-SNAP-IN-GLIDER WITH SEC. RING CLIP turnable</b> <b>HB-SNAP-IN-GLIDER WITH EYELET</b> snap-in / snap-out, removable for rails  PU = 100	white white	769-00 770-00
	<b>SNAP-IN-GLIDER WITH SEC. RING CLIP</b> for rails  PU = 100	white grey black	742-00 -08 -57
	<b>SNAP-IN-GLIDER WITH EYELET</b> for rails  PU = 100	white grey black	743-00 -08 -57
	<b>ROLLER GLIDER WITH SEC. RING CLIP</b> for rails  PU = 100	white grey black	741-00 -08 -57

Ø 24 mm

# Ø 24 mm Accessories

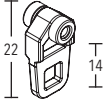
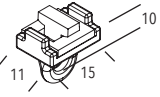
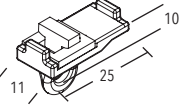
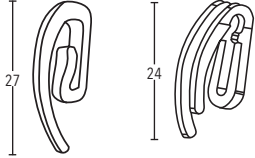
	ARTICLE	FINISH	ARTICLE NO.
	<b>ROLLER GLIDER WITH EYELET</b> for rails  PU = 100	white grey black	748-00 -08 -57
	<b>DRAPERY DIVIDER „ANTI-SLIP“</b> for rails  PU = 100	white grey black	799-20-00 -08 -57
	<b>DRAPERY DIVIDER „ANTI-SLIP“</b> with recess masking for rails  PU = 100	white grey black	799-40-00 -08 -57
	<b>CURTAIN HOOK</b> <b>CURTAIN DOUBLE HOOK</b>  PU = 100	white white	869-00 853-00

# Ø 24 mm Illustrations

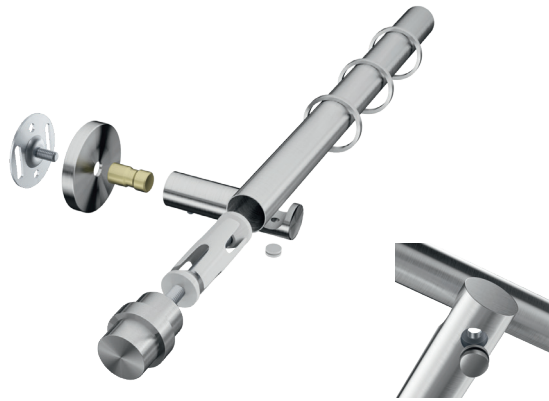

Wall bracket tube installation  
art. no. 244065 + 244120  
Please order cover art. no. 165001 separately

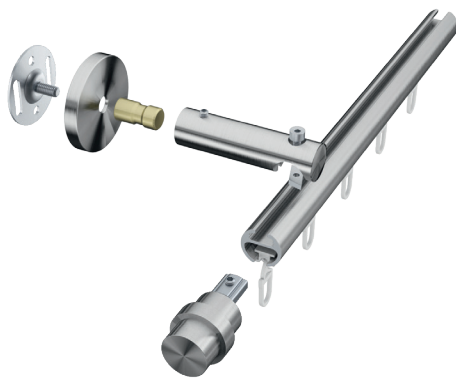
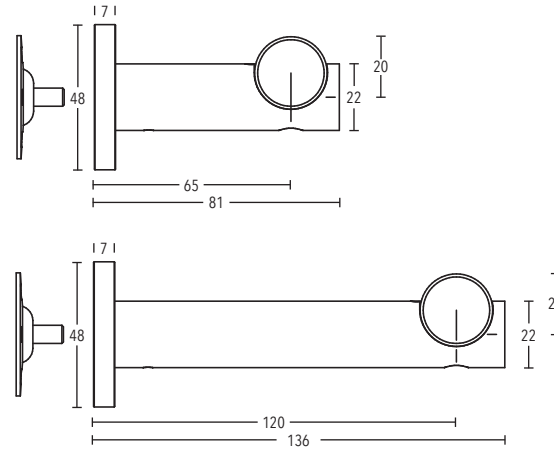

Wall bracket rail installation  
art. no. 244065 + 244120

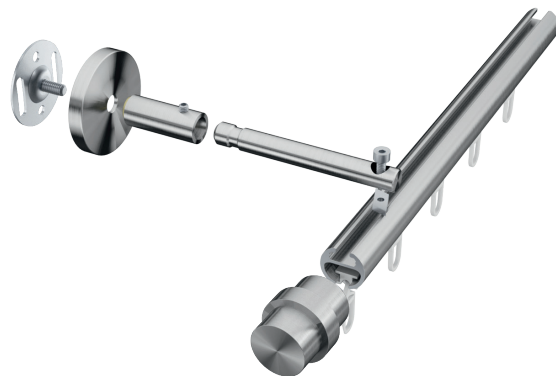
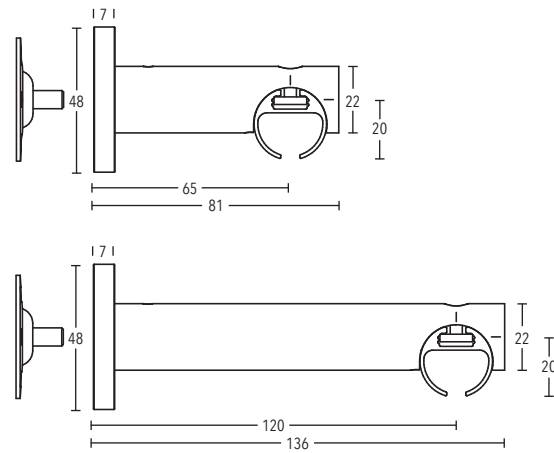

Wall bracket rail installation  
art. no. 284425 + 284500

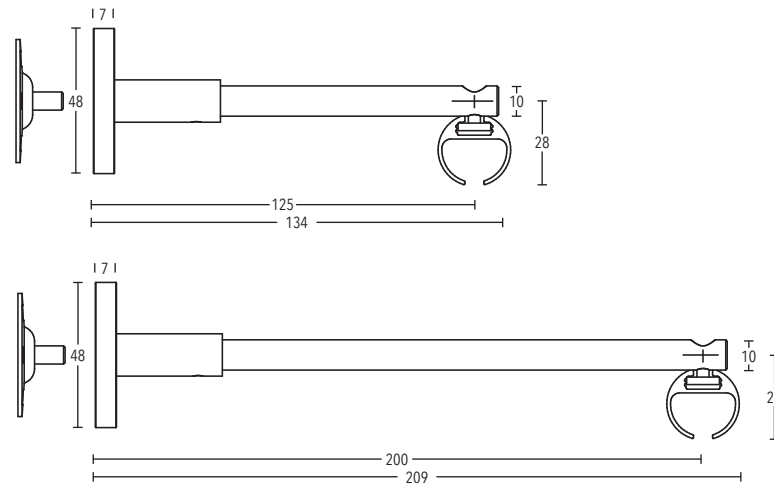

Ø 24 mm

# Ø 24 mm Illustrations

---

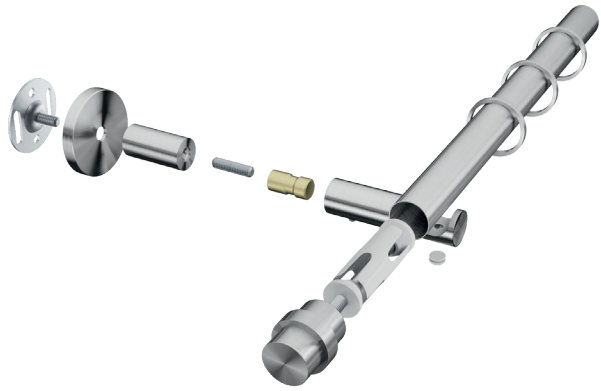

Extension  
art. no. 286040



Ceiling bracket 3 mm  
art. no. 11592

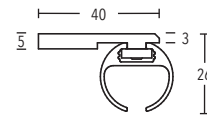

Snap-in Ceiling bracket 5 mm  
art. no. 11693-00

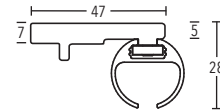

Ceiling bracket 3 mm  
art. no. 11597

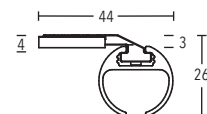

# Ø 24 mm Illustrations



Ceiling bracket 15 mm  
art. no. 164915

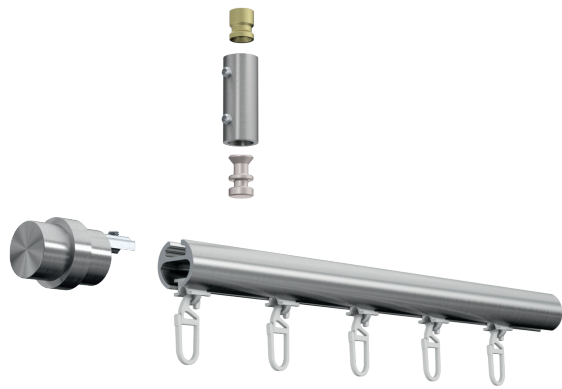
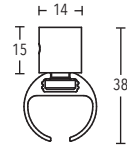

Ceiling bracket 35 mm  
art. no. 164935

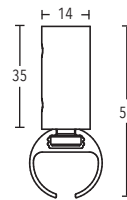

Ceiling bracket 42 mm  
art. no. 164942

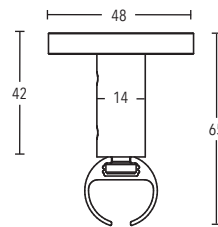

Ceiling bracket 500 mm  
art. no. 164995

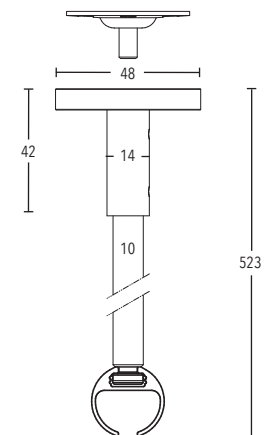



# Ø 24 mm Illustrations

---



Recess bracket  
art. no. 247001

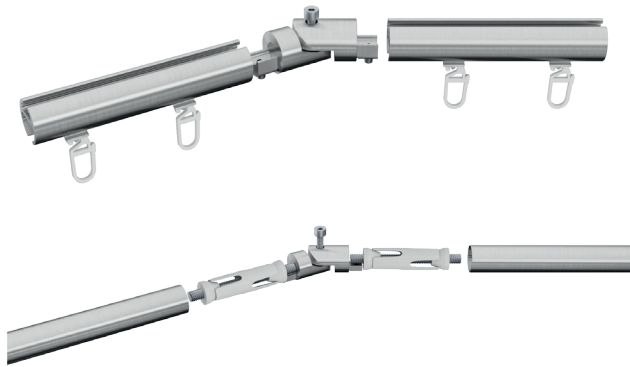
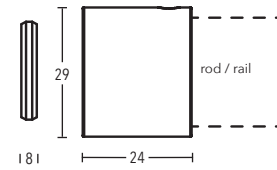

Connector (hinged joint)  
art. no. 122924



Rail connector  
art. no. 899-3-00

Rail connector, adjustable  
art. no. 899-3.1-01



Tube connector  
art. no. 83024-000

# BÜSCHE

## VION

Ø 28 mm

---

white

Pole set no. 4-2911-28

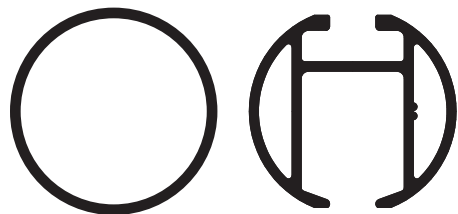

### Available finishes



-28 white



-116 stainless steel



-132 bronze



-157 matt black



-222 wild oak



-223 dumson plum



-328 structure white



-357 structure black





Ø 28 mm

# Ø 28 mm Decorative Pole Sets

WALL- AND CEILING INSTALLATION / ROD SINGLE/DOUBLE / RAIL SINGLE/DOUBLE

---

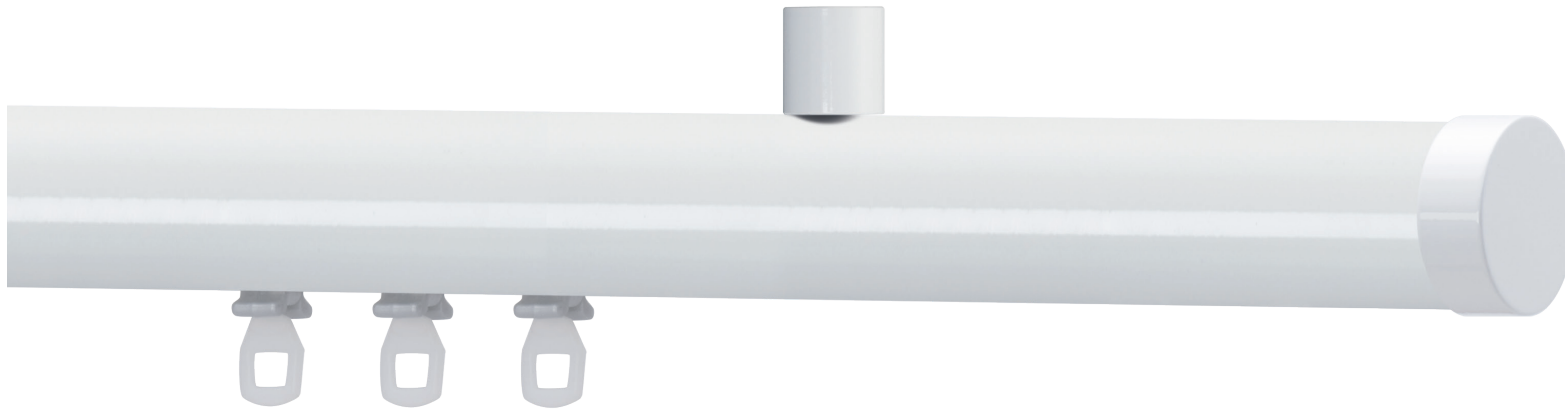

LINE - white - Page 110 - Pole set no. 7-2990-28



FANDO - stainless steel / wild oak - Page 116 - Pole set no. 4-2910-116/222

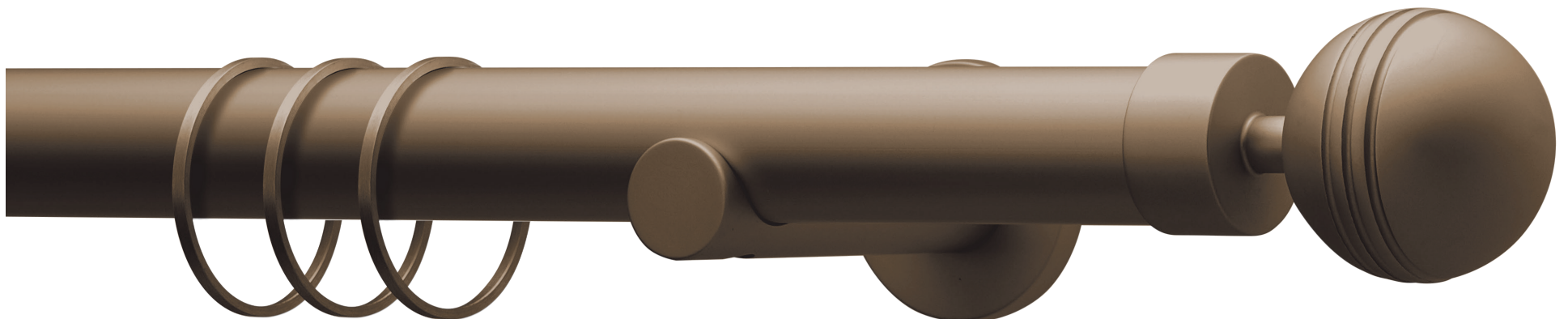

STELO - bronze - Page 114 - Pole set no. 1-2902-132

AVAILABLE FINISHES



-28 white



-116 stainless steel



-132 bronze



-157 matt black



-222 wild oak



-223 dumson plum

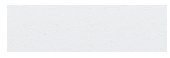

-328 structure white



-357 structure black



ALBA - matt black - Page 112 - Pole set no. 1-2900-157

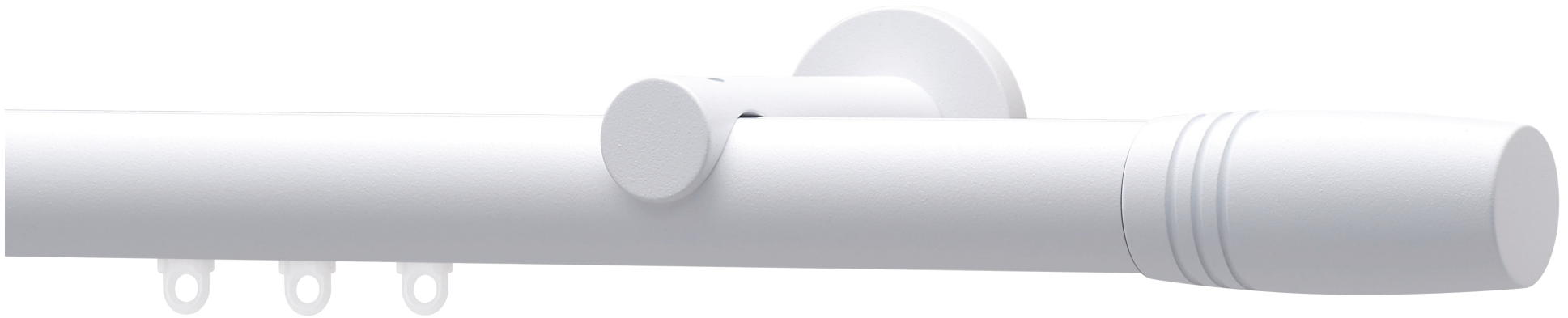

DALIA - structure white - Page 114 - Pole set no. 4-2911-328





LUNGO - structure black - Page 114 - Pole set no. 4-2912-357

Ø 28 mm

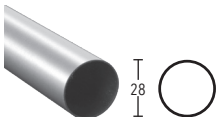
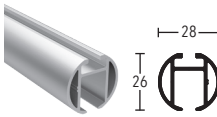
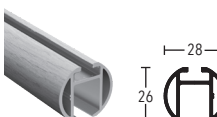
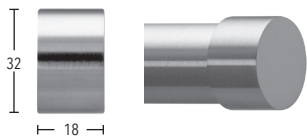
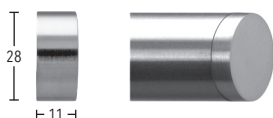
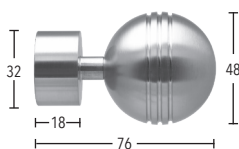
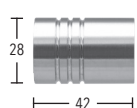
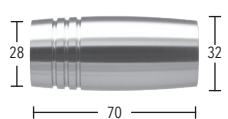
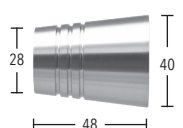
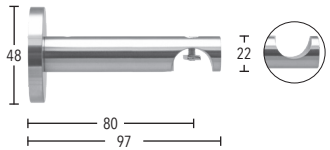

# Ø 28 mm Accessories

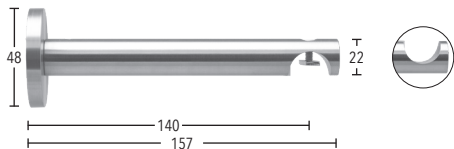
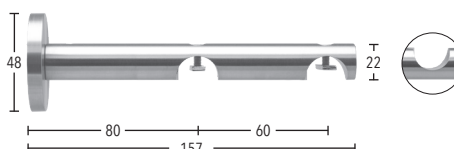
	ARTICLE	FINISH	ARTICLE NO.		
	<b>STAINLESS STEEL-TUBE</b>	stainless steel	800-28-116	fix length (cut to size)	std. length
	<b>ALUMINIUM-TUBE</b> Ø 28 mm standard length 6 m	white bronze matt black	-28 -132 -157		
	<b>ALUMINIUM-RAIL</b> Ø 28 mm standard length 6 m	stainless steel white bronze matt black structure white structure black	808-28-116 -28 -132 -157 -328 -357	fix length (cut to size)	std. length
	<b>WOOD GRAIN EFFECT ALUMINIUM-RAIL</b> Ø 28 mm standard length 6 m	wild oak dumson plum	808-28-222 -223	fix length (cut to size)	std. length
	<b>END CAP ALBA</b> for Ø 28 mm PU = 10	stainless steel white bronze matt black structure white structure black	283000-116 -28 -132 -157 -328 -357		
	<b>END CAP LINE</b> for Ø 28 mm flush finial to fit with tube / rail of equal diameter PU = 10	stainless steel white bronze matt black structure white structure black	283100-116 -28 -132 -157 -328 -357		
	<b>FINIAL STELO</b> for Ø 28 mm PU = 6	stainless steel bronze matt black	283021-116 -132 -157		
	<b>FINIAL FANDO</b> for Ø 28 mm flush finial to fit with tube / rail of equal diameter PU = 6	stainless steel bronze matt black structure white structure black	283031-116 -132 -157 -328 -357		
	<b>FINIAL DALIA</b> for Ø 28 mm flush finial to fit with tube / rail of equal diameter PU = 6	stainless steel bronze matt black structure white structure black	283032-116 -132 -157 -328 -357		
	<b>FINIAL LUNGO</b> for Ø 28 mm flush finial to fit with tube / rail of equal diameter PU = 6	stainless steel bronze matt black structure white structure black	283033-116 -132 -157 -328 -357		
	<b>WALL BRACKET ALUX (System 1- + 4-)</b> single, wall ext. 80 mm without cover (art. no. 165001) for Ø 28 mm rods / rails PU = 10	stainless steel white bronze matt black structure white structure black	284080-116 -28 -132 -157 -328 -357		

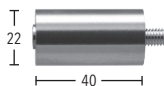
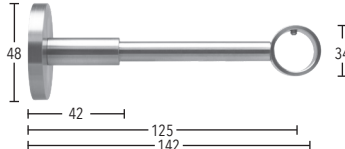
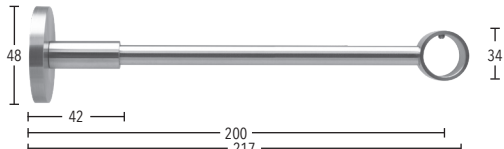
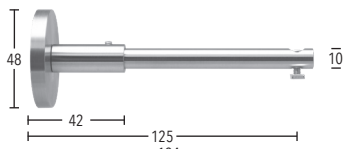
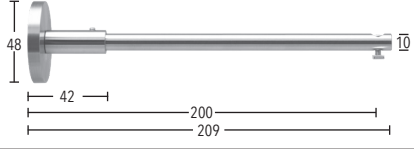
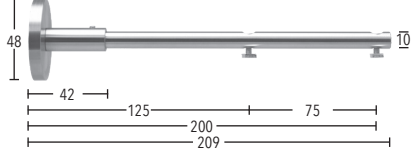
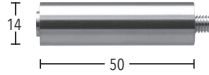
# Ø 28 mm Accessories



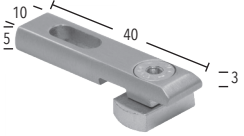
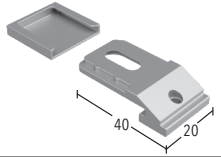
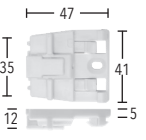

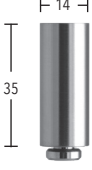
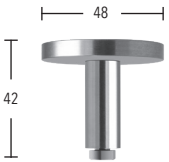
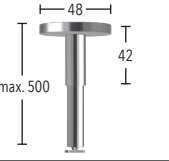
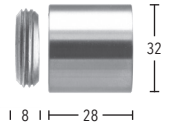
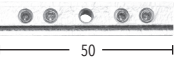
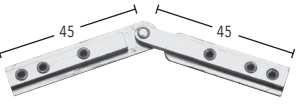

	ARTICLE	FINISH	ARTICLE NO.
	<b>WALL BRACKET ALUX</b> single, wall ext. 140 mm for Ø 28 mm rods / rails without cover (art. no. 165001)	stainless steel white bronze matt black structure white structure black	284140-116 -28 -132 -157 -328 -357
	PU = 10		
	<b>WALL BRACKET ALUX (System 2- + 5-)</b> double, wall ext. 80/140 mm without cover (art. no. 165001) for Ø 28 mm rods/Profile	stainless steel white bronze matt black structure white structure black	285140-116 -28 -132 -157 -328 -357
	PU = 10		
	<b>BORE HOLE INSERT FOR ALL BRACKETES ALUX</b> material stainless steel resp. aluminium to cover bore holes when using the bracket as tube bracket	stainless steel white bronze matt black	165001-116 -28 -132 -157
	PU = 10		
	<b>EXTENSION</b> length 40 mm for all brackets »ALUX«	stainless steel white bronze matt black structure white structure black	286040-116 -28 -132 -157 -328 -357
	PU = 10		
	<b>WALL BRACKET GEO</b> single, wall ext. 125 mm, can be cut for Ø 28 mm rods	stainless steel matt black	284125-116 -157
	PU = 6		
	<b>WALL BRACKET GEO</b> single, wall ext. 200 mm, can be cut for Ø 28 mm rods	stainless steel matt black	284200-116 -157
	PU = 6		
	<b>WALL BRACKET GEO</b> single, wall ext. 125 mm, can be cut for Ø 28 mm rails	stainless steel white bronze matt black	284425-116 -28 -132 -157
	PU = 6		
	<b>WALL BRACKET GEO</b> single, wall ext. 200 mm, can be cut for Ø 28 mm rails	stainless steel white bronze matt black	284500-116 -28 -132 -157
	PU = 6		
	<b>WALL BRACKET GEO</b> double, wall ext. 125/200 mm, can be cut for Ø 28 mm rails	stainless steel matt black	285500-116 -157
	PU = 6		
	<b>EXTENSION</b> length 50 mm for all wall brackets „GEO“	stainless steel white bronze matt black	166050-116 -28 -132 -157
	PU = 10		

# Ø 28 mm Accessories

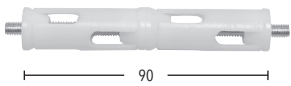
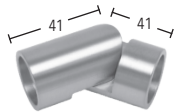
	ARTICLE	FINISH	ARTICLE NO.
	<b>CEILING BRACKET 3 mm (System 6-)</b> single, ceiling ext. 29 mm for rails  PU = 10	silver white black	11592-00 -28 -157
	<b>CEILING BRACKET 3 mm (System 11-)</b> including borehole cover single, ceiling ext. 29 mm for rails  PU = 10	silver white black	11597-00 -28 -157
	<b>SNAP-IN CEILING BRACKET 5 mm (System 10-)</b> single, ceiling ext. 31 mm Material: plastic for rails  PU = 10	white	11693-00
	<b>CEILING BRACKET 15 mm (System 7-)</b> single, ceiling ext. 41 mm for rails  PU = 10	stainless steel white bronze matt black structure white structure black	164915-116 -28 -132 -157 -328 -357
	<b>CEILING BRACKET 35 mm (System 8-)</b> single, ceiling ext. 61 mm for rails  PU = 10	stainless steel white bronze matt black structure white structure black	164935-116 -28 -132 -157 -328 -357
	<b>CEILING BRACKET 42 mm</b> single, ceiling ext. 68 mm with 3-hole mounting plate for rails  PU = 10	stainless steel white bronze matt black structure white structure black	164942-116 -28 -132 -157 -328 -357
	<b>CEILING BRACKET 500 mm</b> single, ceiling ext. 68-526 mm ( can be cut ) with 3-hole mounting plate for rails  PU = 1	stainless steel white matt black structure white structure black	164995-116 -28 -157 -328 -357
	<b>RECESS BRACKET</b> for Ø 28 mm  PU = 10	stainless steel white bronze matt black structure white structure black	287001-116 -28 -132 -157 -328 -357
	<b>RAIL CONNECTOR</b> for rails  PU = 10	silver	899-3-00
	<b>RAIL CONNECTOR</b> adjustable for rails  PU = 10 »Mitring see info page 28«	silver	899-3.1-01

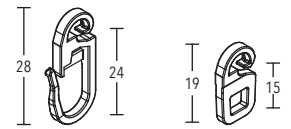
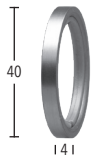
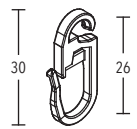

# Ø 28 mm Accessories

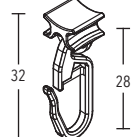
	ARTICLE	FINISH	ARTICLE NO.
	<b>TUBE CONNECTOR</b> for Ø 28 mm rods  PU = 10	white	83028-000
	<b>CONNECTOR (HINGED JOINT)</b> for Ø 28 mm rods and rails  PU = 1	stainless steel matt black	122928-116 -157
	<b>FLAT CURTAIN RING</b> i.d. 44 mm, o.d. 48 mm  PU = 100	stainless steel bronze matt black	225728-116 -132 -57
	<b>SEC. RING CLIP</b> <b>SEC. RING CLIP WITH EYELET</b> for flat curtain ring art. no. 225728  PU = 100	transparent transparent	718-4-00 722-4-00
	<b>FLAT CURTAIN RING</b> i.d. 32 mm, o.d. 40 mm  PU = 100	white	202840-28
	<b>SEC. RING CLIP</b> for flat curtain ring art. no. 202840-28  PU = 100	white	818-6-28
	<b>FLAT CURTAIN RING</b> with plastic insert i.d. 39 mm / o.d. 48 mm  PU = 50	sat. nickel matt black antique brass matt	125830-29 -57 -70
	<b>SEC. RING CLIP</b> for flat curtain ring, with plastic insert art. no. 125830  PU = 100	transparent silver black brown	844-00 -29 -57 -70
	<b>FLAT CURTAIN RING WITH EYELET</b> and plastic insert i.d. 39 mm / o.d. 48 mm  PU = 50	sat. nickel matt black antique brass matt	125930-29 -57 -70
	<b>GLIDER WITH SEC. RING CLIP</b> for rails  PU = 100	white grey black	739-00 -08 -57

# Ø 28 mm Accessories

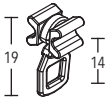
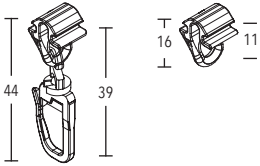
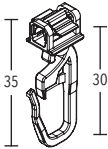
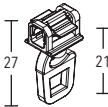
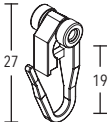
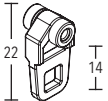
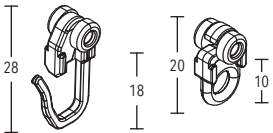
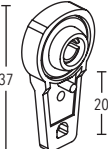
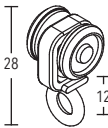
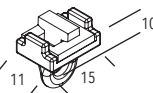
	ARTICLE	FINISH	ARTICLE NO.
	<b>GLIDER WITH EYELET</b> for rails  PU = 100	white grey black	740-00 -08 -57
	<b>HB-SNAP-IN-GLIDER WITH SEC. RING CLIP turnable</b> <b>HB-SNAP-IN-GLIDER WITH EYELET</b> snap-in / snap-out, removable for rails  PU = 100	white white	769-00 770-00
	<b>SNAP-IN-GLIDER WITH SEC. RING CLIP</b> for rails  PU = 100	white grey black	742-00 -08 -57
	<b>SNAP-IN-GLIDER WITH EYELET</b> for rails  PU = 100	white grey black	743-00 -08 -57
	<b>ROLLER GLIDER WITH SEC. RING CLIP</b> for rails  PU = 100	white grey black	741-00 -08 -57
	<b>ROLLER GLIDER WITH EYELET</b> for rails  PU = 100	white grey black	748-00 -08 -57
	<b>ROLLER GLIDER WITH SEC. RING CLIP</b> <b>ROLLER GLIDER WITH EYELET</b> for rails  PU = 100	white white	752-00 751-00
	<b>ROLLER GLIDER WITH BALL BEARING</b> for rails  PU = 100	white	845-00
	<b>ROLLER GLIDER WITH EASY RUNNING ROLLERS</b> for rails  PU = 100	white	848-00
	<b>DRAPERY DIVIDER „ANTI-SLIP“</b> for rails  PU = 100	white grey black	799-20-00 -08 -57

# Ø 28 mm Illustrations

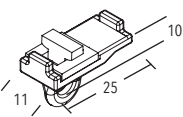
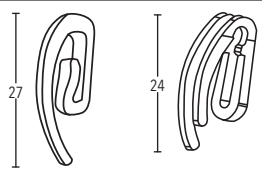
	ARTICLE	FINISH	ARTICLE NO.
	<b>DRAPERY DIVIDER „ANTI-SLIP“</b> with recess masking for rails  PU = 100	white grey black	799-40-00 -08 -57
	<b>CURTAIN HOOK</b> <b>CURTAIN DOUBLE HOOK</b>  PU = 100	white white	869-00 853-00

Wall bracket tube installation  
art. no. 284080 + 284140  
Please order cover art. no. 165001 separately

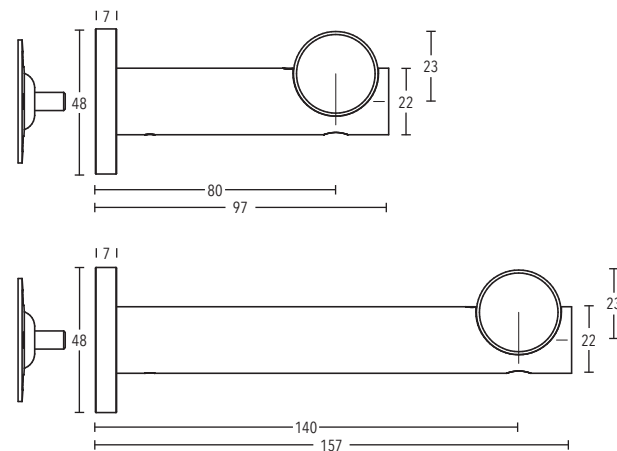
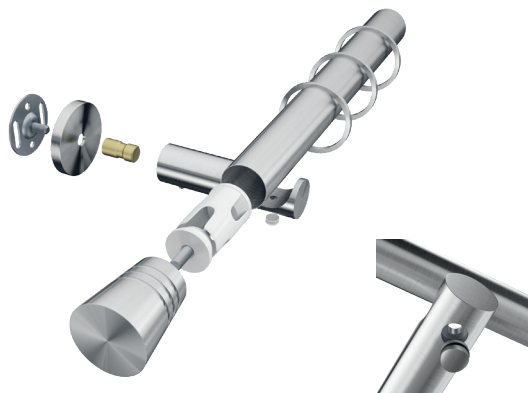

Wall bracket rail installation  
art. no. 284080 + 284140

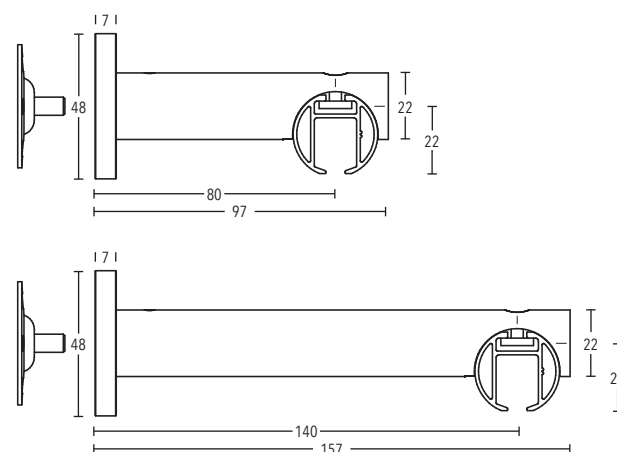
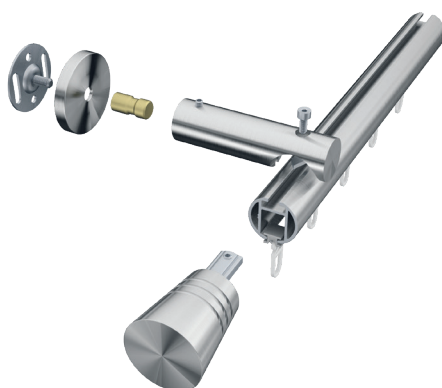

# Ø 28 mm Illustrations

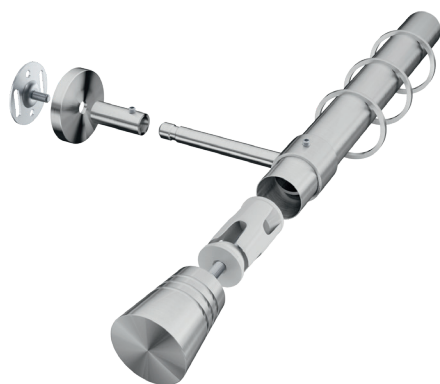

Wall bracket tube installation  
art. no. 284125 + 284200

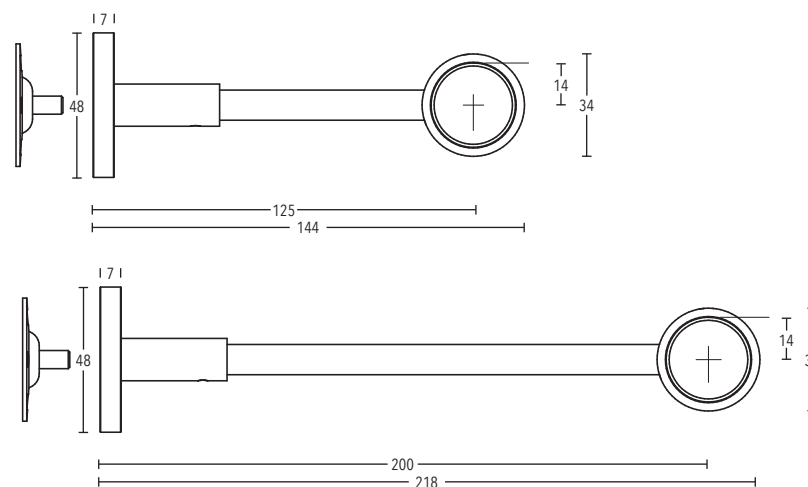

Wall bracket rail installation  
art. no. 284425 + 284500

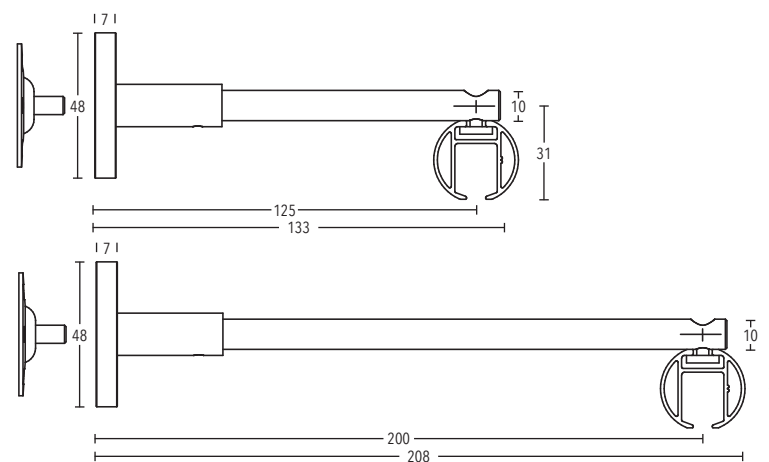

Ceiling bracket 3 mm  
art. no. 11592

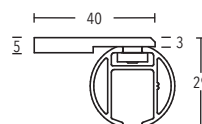

# Ø 28 mm Illustrations

---



Snap-in Ceiling bracket 5 mm  
art. no. 11693-00

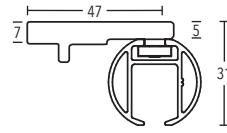

Ceiling bracket 3 mm  
art. no. 11597

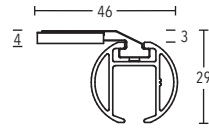

Ceiling bracket 15 mm  
art. no. 164915

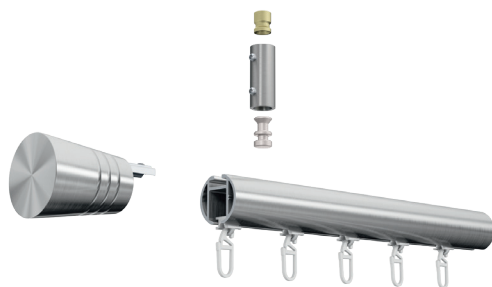
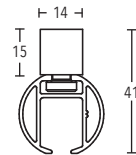

Ceiling bracket 35 mm  
art. no. 164935

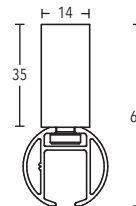

# Ø 28 mm Illustrations

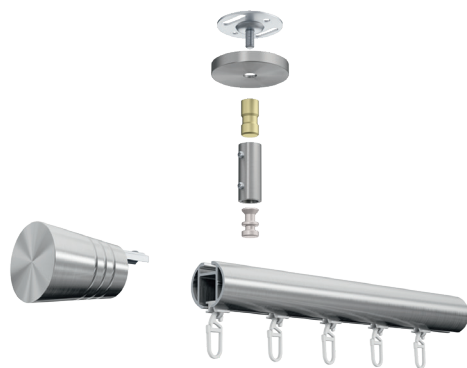

Ceiling bracket 42 mm  
art. no. 164942

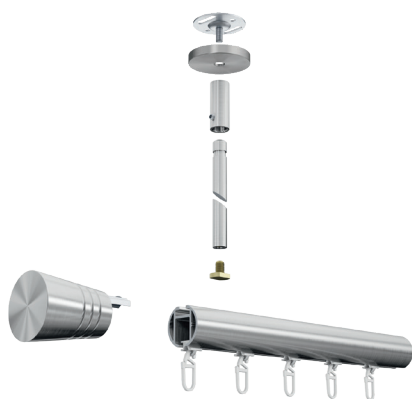
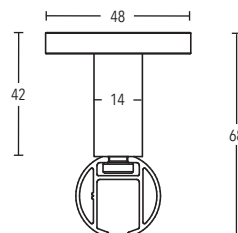

Ceiling bracket 500 mm  
art. no. 164995

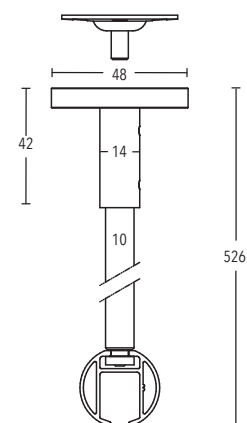

Recess bracket  
art. no. 287001

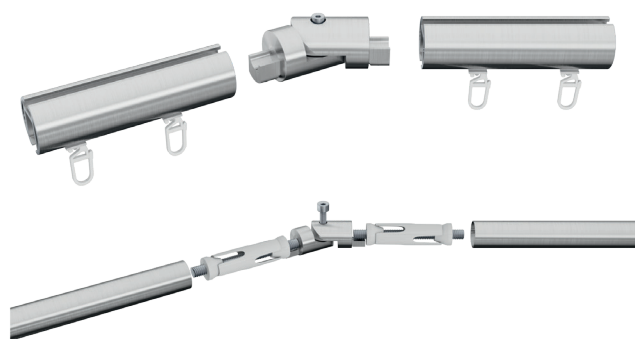
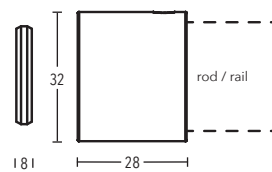

Connector (hinged joint)  
art. no. 122928

## Ø 28 mm Illustrations

---



Rail connector  
art. no. 899-3-00



Rail connector, adjustable  
art. no. 899-3.1-01

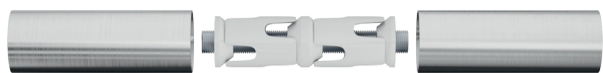

Tube connector  
art. no. 83028-000

# BÜSCHE

## VION

Ø 35 mm

---

stainless steel

Pole set no. **4-3690-116**



Available finishes



-116 stainless steel







Ø 35 mm

# Ø 35 mm Decorative Pole Sets

WALL- AND CEILING INSTALLATION / RAIL SINGLE/DOUBLE

---



ALBA - stainless steel - Page 134 - Pole set no. 4-3600-116

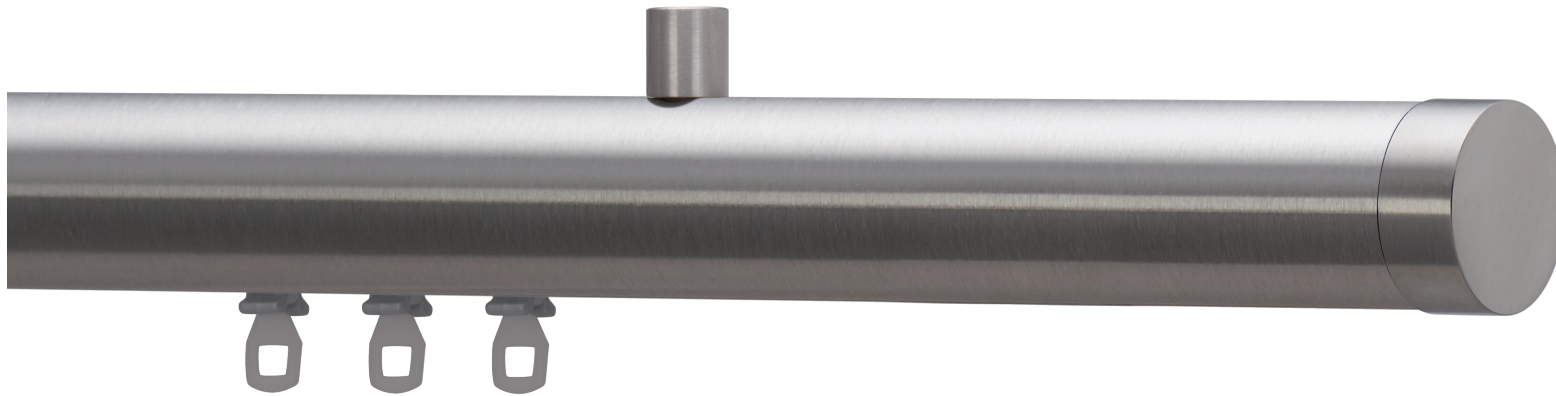

LINE - stainless steel - Page 132 - Pole set no. 7-3690-116

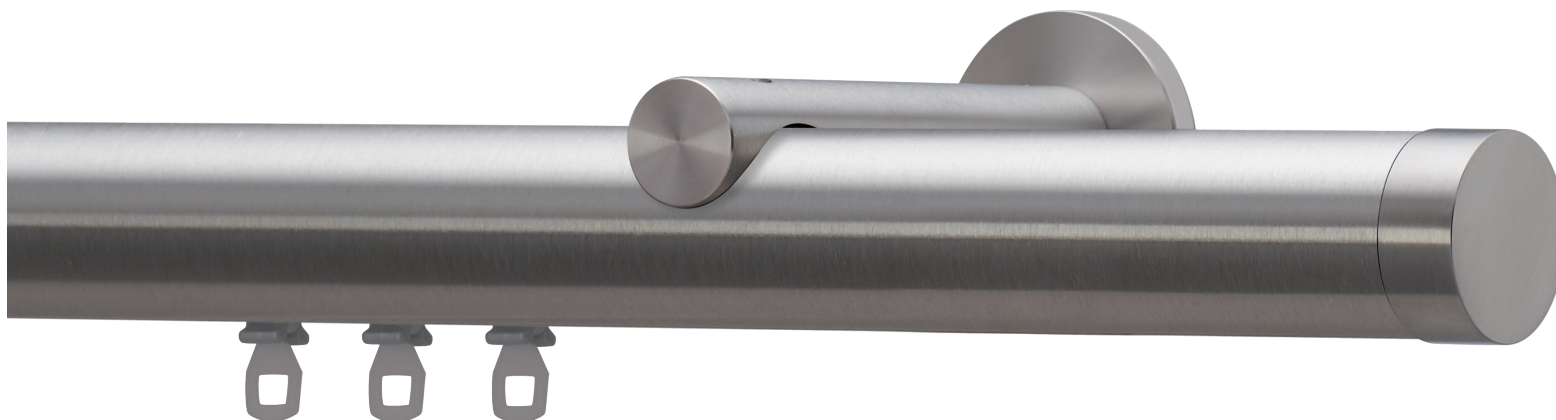

LINE - stainless steel - Page 134 - Pole set no. 4-3690-116

AVAILABLE FINISHES



-116 stainless steel



ALBA - stainless steel - Page 134 - Pole set no. 5-3600-116





LINE - stainless steel - Page 134 - Pole set no. 5-3690-116

Ø 35 mm

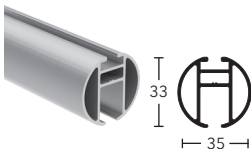
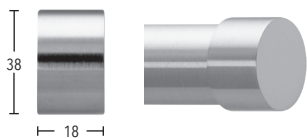
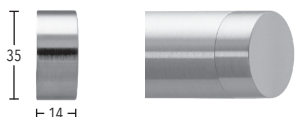
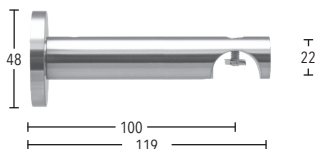
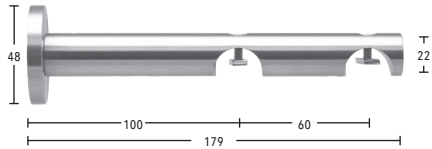
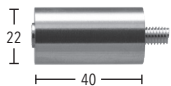
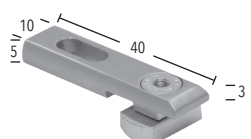
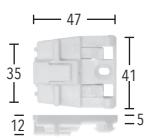
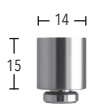
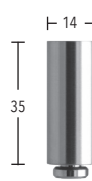
# Ø 35 mm Accessories

	ARTICLE	FINISH	ARTICLE NO.	
	<b>ALUMINIUM-RAIL</b> Ø 35 mm  standard length 6 m	stainless steel	808-35-116	fix length (cut to size)      std. length
	<b>END CAP ALBA</b> for Ø 35 mm  PU = 10	stainless steel	353000-116	
	<b>END CAP LINE</b> for Ø 35 mm flush finial to fit with tube / rail of equal diameter  PU = 10	stainless steel	353100-116	
	<b>WALL BRACKET ALUX (System 4-)</b> single, wall ext. 100 mm for Ø 35 mm rails  PU = 10	stainless steel	354100-116	
	<b>WALL BRACKET ALUX (System 5-)</b> double, wall ext. 100/160 mm for Ø 35 mm rails  PU = 10	stainless steel	355160-116	
	<b>EXTENSION</b> length 40 mm for all brackets »ALUX«  PU = 10	stainless steel	286040-116	
	<b>CEILING BRACKET 3 mm (System 6-)</b> single, ceiling ext. 36 mm for rails  PU = 10	silver white	11592-00 -28	
	<b>SNAP-IN CEILING BRACKET 5 mm (System 10-)</b> single, ceiling ext. 38 mm Material: plastic for rails  PU = 10	white	11693-00	
	<b>CEILING BRACKET 15 mm (System 7-)</b> single, ceiling ext. 48 mm for rails  PU = 10	stainless steel	164915-116	
	<b>CEILING BRACKET 35 mm (System 8-)</b> single, ceiling ext. 68 mm for rails  PU = 10	stainless steel	164935-116	

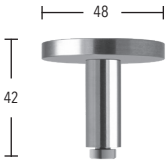
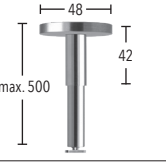
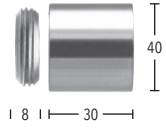
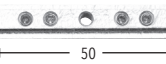
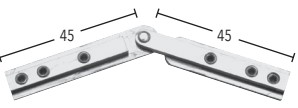
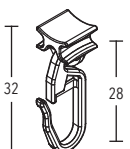
# Ø 35 mm Accessories

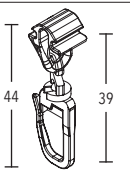
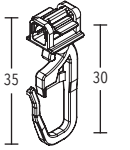
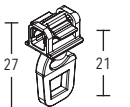
	ARTICLE	FINISH	ARTICLE NO.
	<b>CEILING BRACKET 42 mm (System 9-)</b> single, ceiling ext. 75 mm with 3-hole mounting plate for rails  PU = 10	stainless steel	164942-116
	<b>CEILING BRACKET 500 mm</b> single, ceiling ext. 75-533 mm ( can be cut ) with 3-hole mounting plate for rails  PU = 1	stainless steel	164995-116
	<b>RECESS BRACKET</b> for Ø 35 mm  PU = 10	stainless steel	357001-116
	<b>RAIL CONNECTOR</b> for rails  PU = 10	silver	899-3-00
	<b>RAIL CONNECTOR</b> adjustable for rails  PU = 10 »Mitring see info page 28«	silver	899-3.1-01
	<b>GLIDER WITH SEC. RING CLIP</b> for rails  PU = 100	white grey	739-00 -08
	<b>GLIDER WITH EYELET</b> for rails  PU = 100	white grey	740-00 -08
	<b>HB-SNAP-IN-GLIDER WITH SEC. RING CLIP turnable</b> <b>HB-SNAP-IN-GLIDER WITH EYELET</b> snap-in / snap-out, removable for rails  PU = 100	white white	769-00 770-00
	<b>SNAP-IN-GLIDER WITH SEC. RING CLIP</b> for rails  PU = 100	white grey	742-00 -08
	<b>SNAP-IN-GLIDER WITH EYELET</b> for rails  PU = 100	white grey	743-00 -08

# Ø 35 mm Accessories

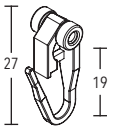
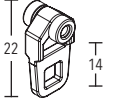
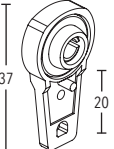
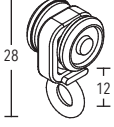
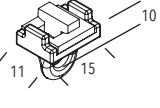
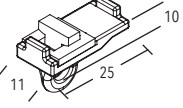
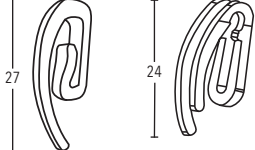
	ARTICLE	FINISH	ARTICLE NO.
	<b>ROLLER GLIDER WITH SEC. RING CLIP</b> for rails  PU = 100	white grey	741-00 -08
	<b>ROLLER GLIDER WITH EYELET</b> for rails  PU = 100	white grey	748-00 -08
	<b>ROLLER GLIDER WITH BALL BEARING</b> for rails  PU = 100	white	845-00
	<b>ROLLER GLIDER WITH EASY RUNNING ROLLERS</b> for rails  PU = 100	white	848-00
	<b>DRAPERY DIVIDER „ANTI-SLIP“</b> for rails  PU = 100	white grey	799-20-00 -08
	<b>DRAPERY DIVIDER „ANTI-SLIP“</b> with recess masking for rails  PU = 100	white grey	799-40-00 -08
	<b>CURTAIN HOOK</b> <b>CURTAIN DOUBLE HOOK</b>  PU = 100	white white	869-00 853-00

# Ø 35 mm Illustrations



Wall bracket rail installation  
art. no. 354100

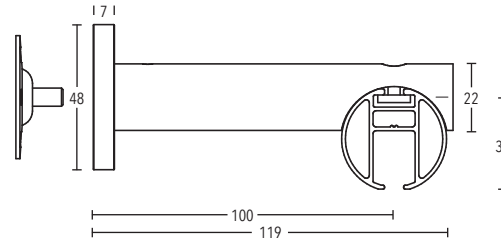

Ceiling bracket 3 mm  
art. no. 11592

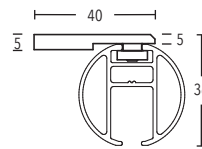

Snap-in Ceiling bracket 5 mm  
art. no. 11693-00

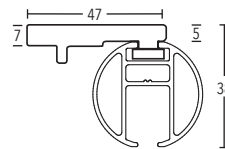

Ceiling bracket 15 mm  
art. no. 164915

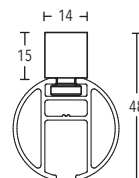

# Ø 35 mm Illustrations



Ceiling bracket 35 mm  
art. no. 164935

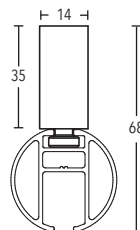

Ceiling bracket 42 mm  
art. no. 164942

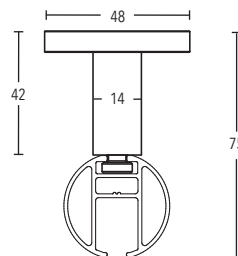

Ceiling bracket 500 mm  
art. no. 164995

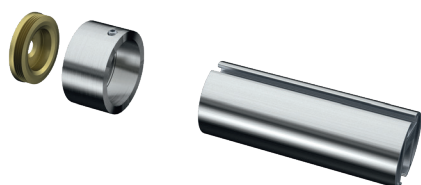
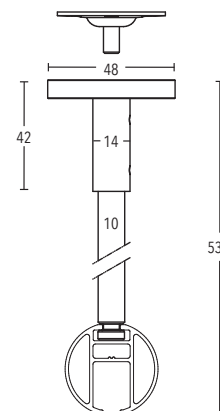

Recess bracket  
art. no. 357001

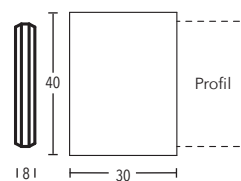



## Ø 35 mm Illustrations

---



Rail connector  
art. no. 899-3-00



Rail connector, adjustable  
art. no. 899-3.1-01

### Accessories

---

#### Available finishes:



-28 white



-48 white matt



-108 silver



-109 gold



-116 stainless steel



-132 bronze



-157 black matt



-328 structure white



-357 structure black

#### **Notes:**







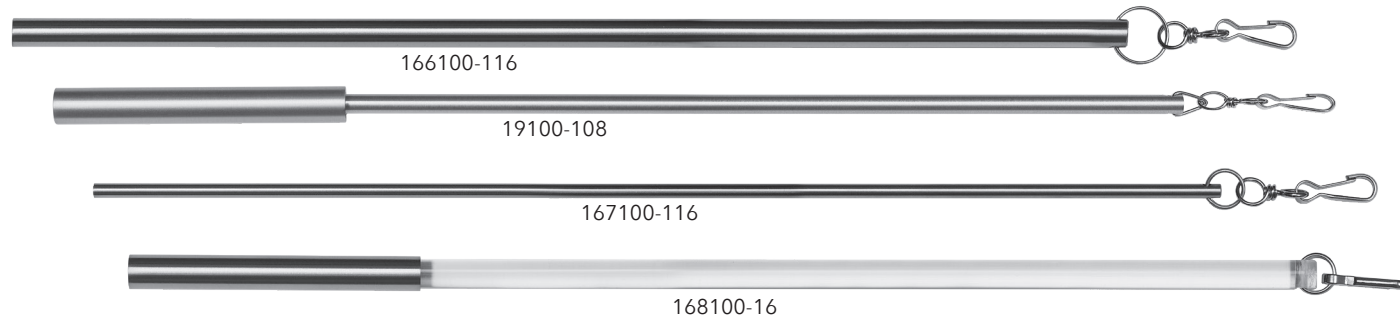

Further accessories in the catalog **INSIDE** from page 204











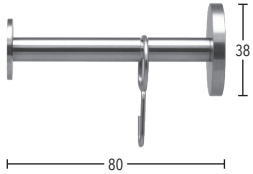
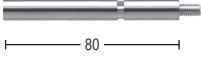

# Accessories



	ARTICLE	FINISH	ARTICLE NO.
	<b>DRAW ROD</b> Length 100 cm  PU = 1	stainless steel white silver gold bronze black matt	166100-116 -28 -108 -109 -132 -157
	<b>DRAW ROD</b> Length 125 cm  PU = 1	stainless steel white silver gold bronze black matt	166125-116 -28 -108 -109 -132 -157
	<b>DRAW ROD</b> Length 150 cm  PU = 1	stainless steel white silver gold bronze black matt	166150-116 -28 -108 -109 -132 -157
	<b>DRAW ROD 100 cm</b> with solid aluminium handle Shaft diameter (rod) 6 mm  PU = 1	white matt silver black matt	19100-48 -108 -157
	<b>DRAW ROD 125 cm</b> with solid aluminium handle Shaft diameter (tube) 6 mm  PU = 1	white matt silver black matt	19125-48 -108 -157
	<b>DRAW ROD 150 cm</b> with solid aluminium handle Shaft diameter (tube) 6 mm  PU = 1	white matt silver black matt	19150-48 -108 -157
	<b>DRAW ROD 100 cm</b> stainless steel Shaft diameter (rod) 5 mm  PU = 1	stainless steel	167100-116
	<b>DRAW ROD ACRYLIC 100 cm</b> with solid stainless steel handle Shaft diameter (rod) 10 mm  PU = 1	stainless steel / acrylic	168100-16

# Accessories

	ARTICLE	FINISH	ARTICLE NO.
	<b>TIE BACK RONDO</b> extension 80 mm complete with assembly accessories  PU = 10	stainless steel white silver gold bronze black matt structure white structure black	108080-116 -28 -108 -109 -132 -157 -328 -357
	<b>EXTENSION</b> length 80 mm for tie back  PU = 10	stainless steel white silver gold bronze black matt structure white structure black	11760/2-116 -28 -108 -109 -132 -157 -328 -357
	<b>METAL-CARE SPRAY</b> for protection and cleaning of satined and polished metal surfaces, e.g. stainless steel, aluminium and brass PU = 1 <b>PTFE SPRAY</b> dry film lubricant for rails  PU = 1		90350-00  90336-00
	<b>CLEANING SPONGE</b> for all anodized aluminium-parts  PU = 1		92625-00
	<b>PUNCHING PLIERS</b>  for 6 mm runs PU = 1		8080-00
	<b>NYLON BENDING INLAY</b> made of plastic for Ø 16 mm rails PU = 1	white	8086 -00
	<b>NYLON BENDING INLAY</b> made of plastic for Ø 20 mm rails for PU = 1	white	8088 -00
	<b>NYLON BENDING INLAY</b> made of plastic for Ø 24 mm rails  PU = 1	white	8087 -00
	<b>NYLON BENDING INLAY</b> made of plastic for Ø 28 mm rails  PU = 1	white	8089 -00

