



TEEC DOR

MADE IN GERMANY

IQ-Series

BÜSCHE

BÜSCHE
150
years
* ————— Anniversary ————— *

It is with pride and gratitude that I look back on the 150-year history of BÜSCHE. Since 1872, BÜSCHE has been developing, manufacturing and selling products exclusively with the label „Made in Germany“.

For generations, the name BÜSCHE stands for tradition combined with the strong desire to actively shape the future. The focus is on sustainability, social responsibility and the continuous development of the BÜSCHE brand.

My heartfelt thanks go to all those who have accompanied us on this long journey and whose thoughts and actions have made BÜSCHE GmbH & Co. KG into a globally successful family business.

Fernando Sanchez

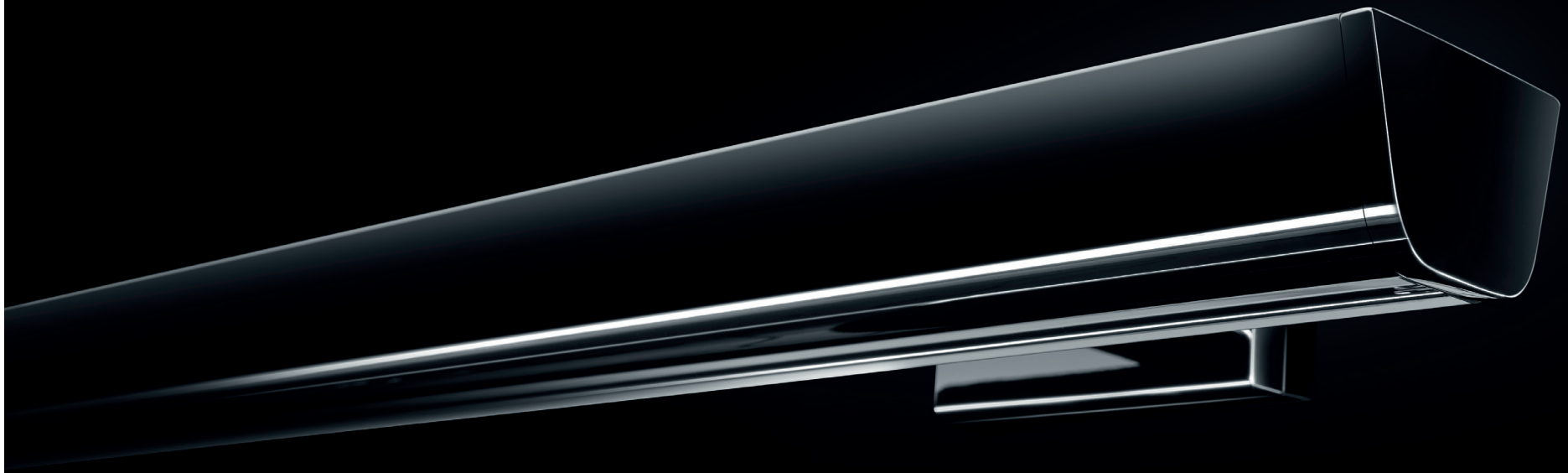

MOTOR AND CORD SETS MADE IN GERMANY

With the extension of the TECDOR IQ-Series, BÜSCHE presents a variety of decorative motorized and corded sets with the highest standards of design and technology. The result is Smart-Home compatible motorized curtain sets and traditional corded systems Made in Germany.

Developed for a design-oriented and technophile clientele, Tecdor IQ-Series is the new innovative solution in modern window decoration.

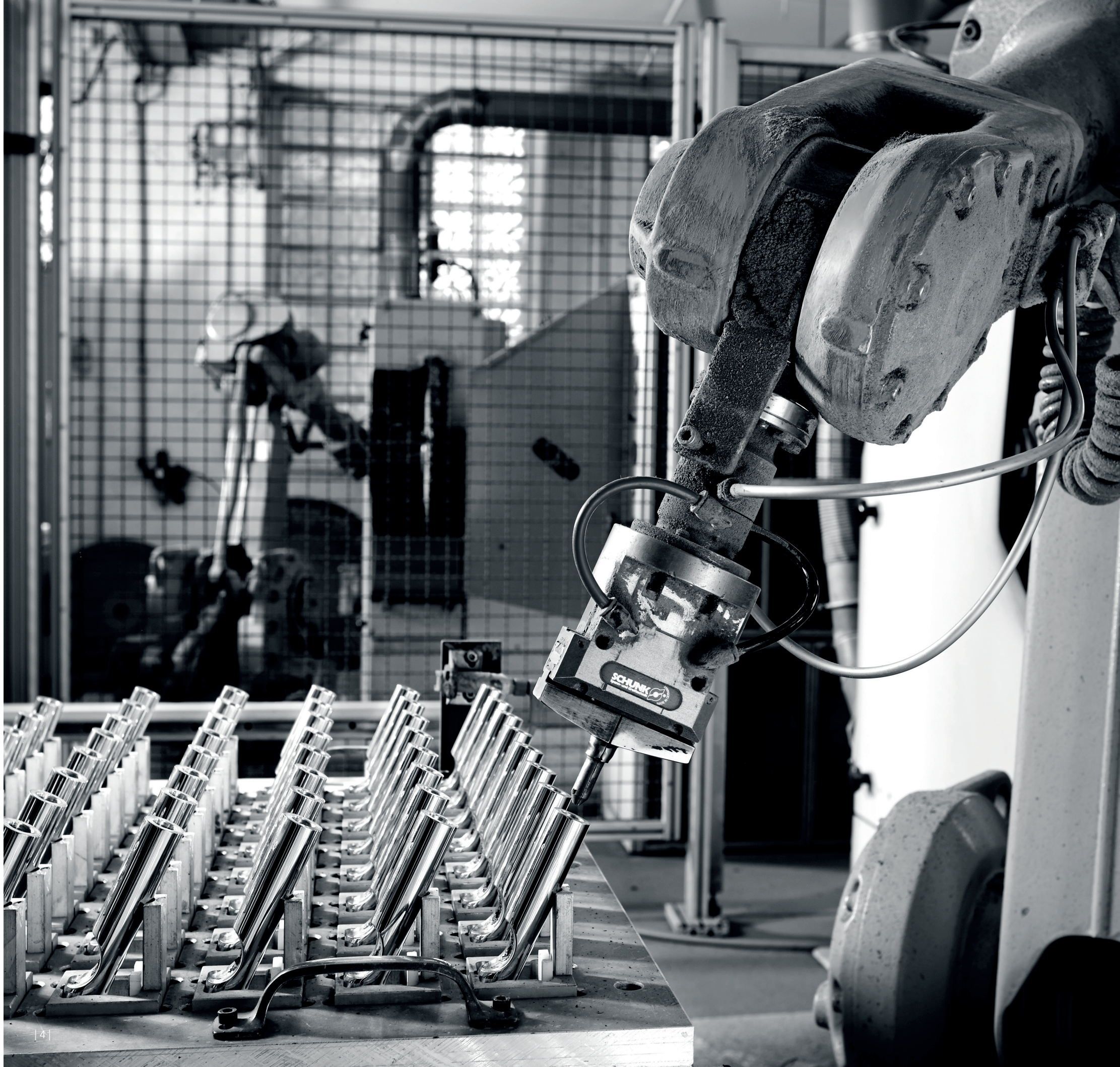

QUALITY IN ALL AREAS MADE IN GERMANY

The term quality describes the overall impression of a product in terms of technical precision, design, haptics and sustainability. As one of the few German suppliers of curtain sets, BÜSCHE manufactures its products exclusively in Neuenrade with the predicate „Made in Germany“.

Process-optimized production methods and the craftsmanship of dedicated employees create the basis for excellent functionality and durability. In close cooperation with international product designers, new shapes and unique products are created: unmistakable, unique and with the highest precision.

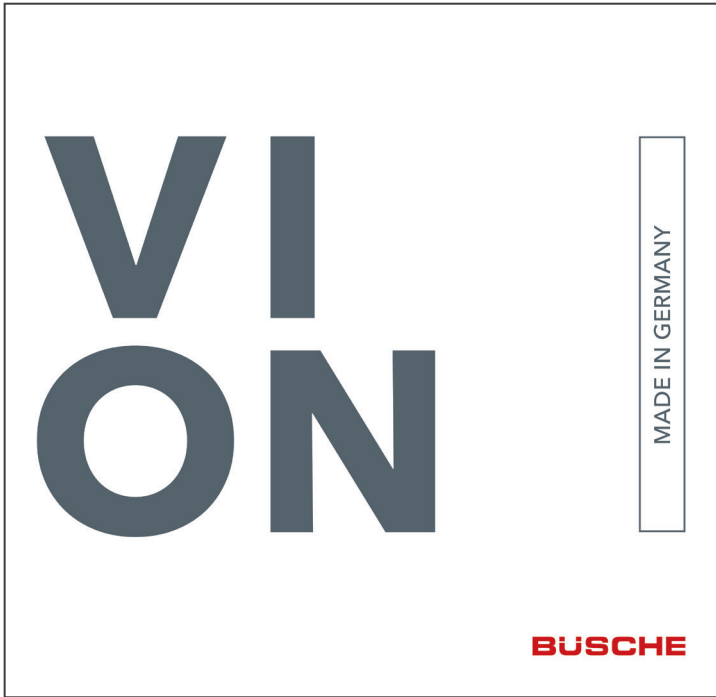

THE BÜSCHE BRAND STRATEGY

The umbrella brand BÜSCHE and the associated brands VION, INSIDE and TECDOR provide wholesalers all over the world with a unique product portfolio of curtain sets and accessories for window decoration.

With a clear commitment to national and international wholesalers, BÜSCHE underlines its reliability and sets clear accents in the cooperation with its partners. BÜSCHE offers the retail trade a unique variety of products combined with a high level of security, exclusivity, reliability and support.



BÜSCHE FOCUSED ON RESPONSIBILITY

Craftsmanship, high-quality materials from sustainable German production, CO2-optimized manufacturing processes, the increasing use of lead-free brass and packaging materials reduced to the essentials are just a few examples of the ecological responsibility in the BÜSCHE philosophy.

All products are manufactured by hand according to European environmental guidelines and are anodized or electroplated depending on the finish.

Only solid turned and milled products are used. The result are finishes with an impressive appearance and individual color tones.

High qualified employees and the use of modern CNC-controlled production machines and robotic systems guarantee a quality that is appreciated by customers all over the world. Visit us in Neuenrade and convince yourself of the diversity of our production and the unique quality „Made in Germany“.

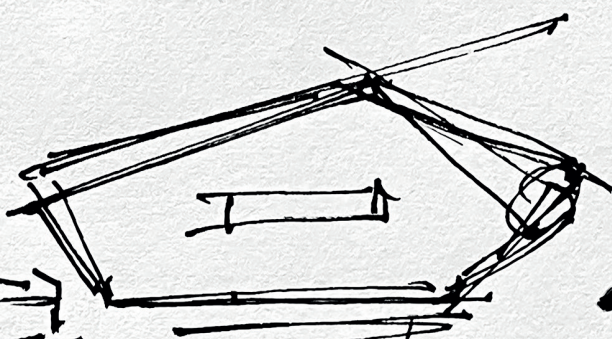

SEITE
SCHWARZ
ZEICHEN
SIZES
CHRON

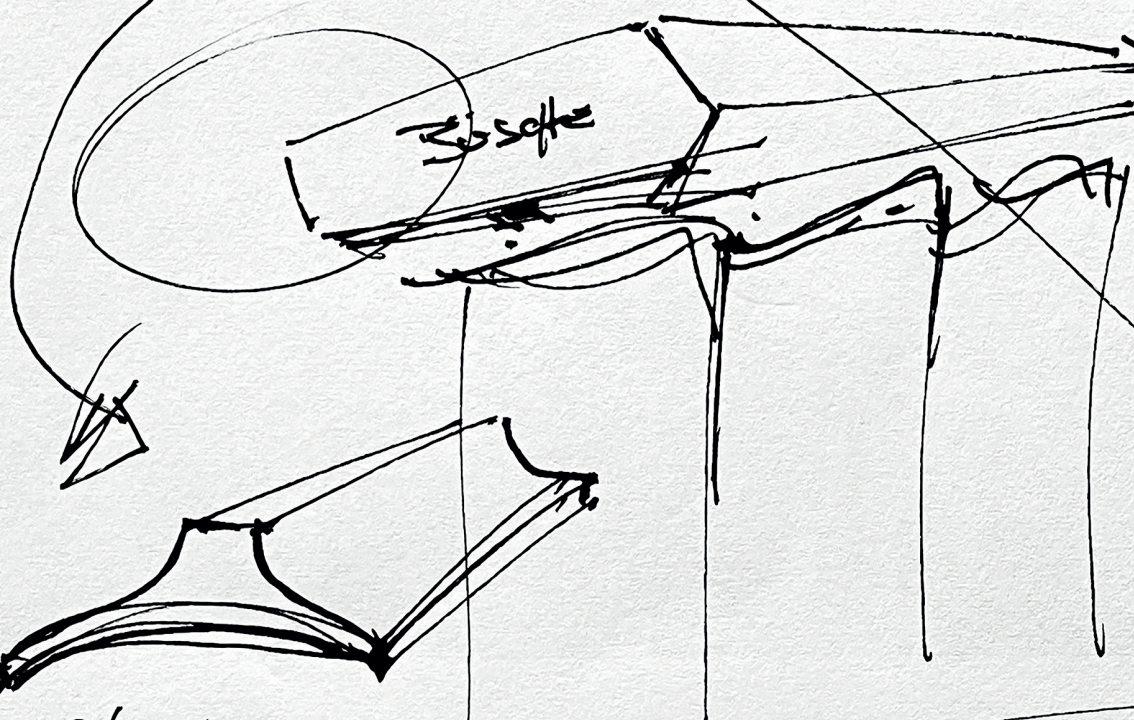

Wiese

(A)

ROUNDY

STATEMENT!!

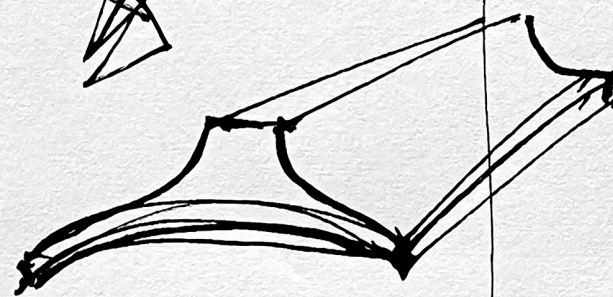

SPELIER

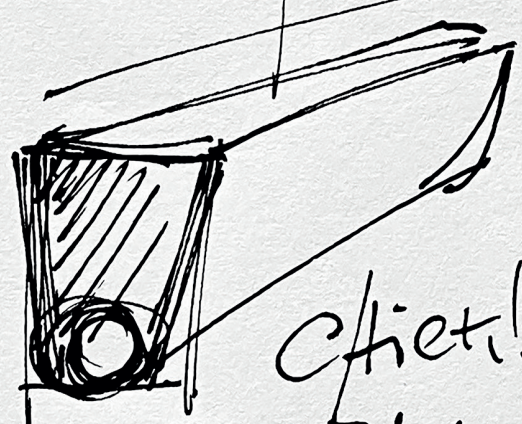

CHIEF!
STALL

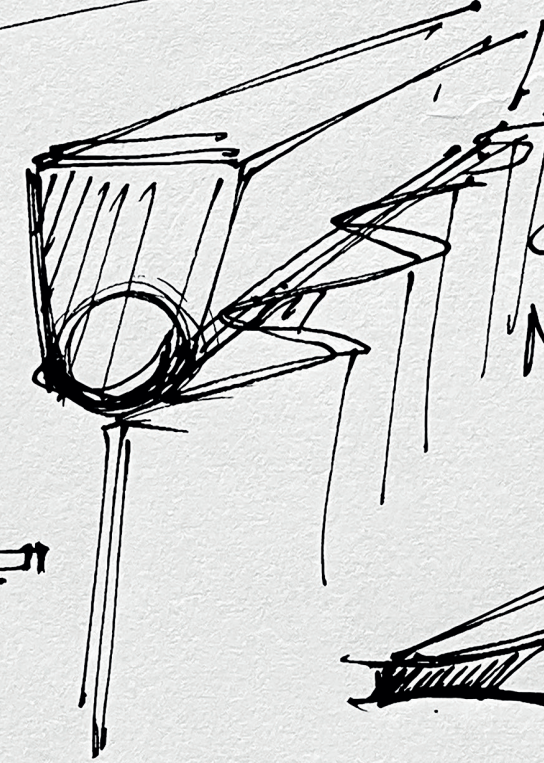

LOW
CHRON
NEOW?

NICHT
SICHTBAR!

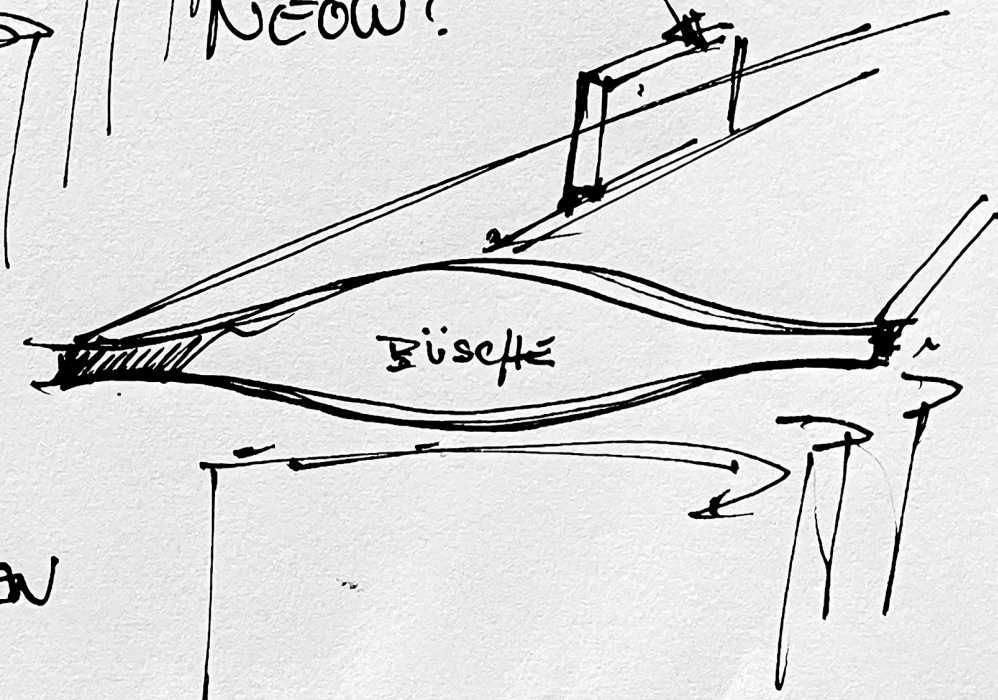
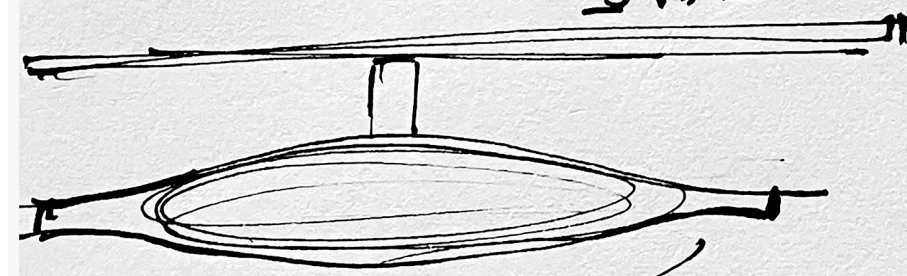

BÜSCHE

MILLING?

SCHWEBEN



SCHMIDDEM PRODUCT DESIGN, LIVING PASSION.

Wishes, dreams, visions: Schmidem Design delivers the designs. For Jochen Schmidem, it's the little things that make a product into an experience. Each one is unique in form and concept, just as each company is unique. The result is a distinctive product that is precisely tailored to the wishes and targets of the client and its markets.

In the process, limits are crossed deliberately in order to create the perfect product by combining functionality, durability and emotionality.

This requires innovative companies that are interested in more than just the product; for whom innovation and sustainability are not just bold marketing words, but an integral part of the corporate culture, from the first draft to the finished product.

In BÜSCHE, Jochen Schmidem has found the perfect partner. Seven new products - PUR, COS, LEP, BOW, NEXUS, COLAR and CALA - have been created, and some of them have already won several design awards.

Team spirit, trust, passion and innovative action characterize the BÜSCHE company: unmistakable, unique and manufactured with the highest precision.

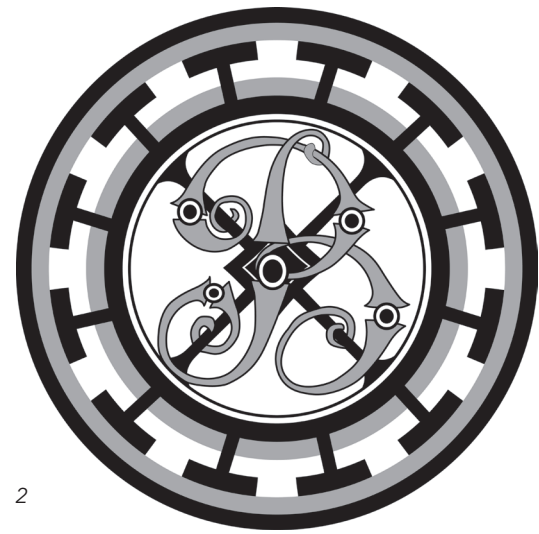

BÜSCHE

150 YEARS MADE IN GERMANY

The BÜSCHE company history began in 1872 with the foundation of a company for the production of wood screws by Heinrich Büsche. In the 50's and 60's, under the management of Fritz Büsche, the company began to produce hooks for wardrobes, rope fittings, eyelets, curtain rings, tie-backs, carpet rods and the first curtain sets.

TECHNOLOGICAL PROGRESS AND EXPANSION

The expansion of the product portfolio and the increasing globalization of the BÜSCHE brand led to continuous technological development in all areas of the company over the following decades. Existing systems were replaced by modern CNC machines, environmentally friendly cleaning systems and computer-controlled grinding and polishing robots.

NEW BUILDING AND STRENGTHENING THE BÜSCHE BRAND

In 2014, BÜSCHE invested in the construction of a 2,300 m² logistics center, which is now used for order picking, storage of finished products, order processing and production. With the publication of the 2015 product catalog, the brands BÜSCHE INSIDE, BÜSCHE TECDOR and BÜSCHE VION were presented under the main brand BÜSCHE.

ACTIVE MANAGEMENT OF THE FUTURE

This year BÜSCHE is celebrating its 150th anniversary. Time to look back with gratitude, but also an important occasion to look into the future.

In addition to strengthening the BÜSCHE brand, combined with the continuous development of products, finishes, optimization of gliding properties and services, the establishment of sustainable production is at the top of the agenda.

Already today, more and more materials from carbon-optimized production and lead-free brass are being processed. Investment in a new CNC turning machine suitable for processing this type of brass, a new exhaust system for the polishing department to protect employees and the environment, and the installation of a degreasing system based on the latest environmental regulations are all planned for this anniversary year.

With the purchase of an adjoining commercial property of 3,000 m² for production and assembly, BÜSCHE GmbH & Co. KG has set another example for a sustainable, socially responsible and successful future.

Shareholders and General Managers from 1872 UNTIL TODAY

1872 - 1923 Heinrich Büsche
1923 - 1961 Fritz Büsche
1958 - 2006 Harro Schumann
1996 - 2014 Friedrich Harr
1999 - today Fernando Sanchez







TEEC DOOR

MADE IN GERMANY

IQ-Series

BUSCHE

Tape

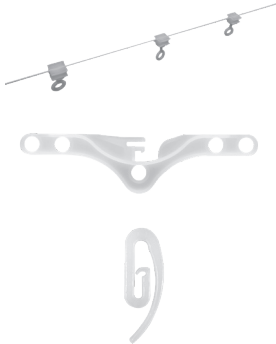
	ARTICLE	FINISH	ARTICLE NO.	
	TAPE LaOla 75 mm - 50 m Role	transparent	960-50-00	
	TAPE LaOla 75 mm - 100 m Role	transparent	960-100-00	
	TAPE LaOla 120 mm - 50 m Role	transparent	970-50-00	
	TAPE LaOla 120 mm - 100 m Role with marked pockets, 100% PES,	transparent	970-100-00	
	LaOla GLIDERCHAIN gliderdistance 80 mm for all rails	white	25,5 m	961-25-00
		grey	25,5 m	-08
		black	25,5 m	-57
		white	50,3 m	961-50-00
		grey	50,3 m	-08
		black	50,3 m	-57
		white	100 m	961-100-00
		grey	100 m	-08
black	100 m	-57		
	LaOla GLIDERCHAIN turnable Teflon coated gliderdistance 80 mm for all rails	white	25 m	966-25-00
		grey	25 m	-08
		black	25 m	-57
	ENDSTOPPER, 2-parts for beginning and end of folding for LaOla gliderchain art. no. 961 Price € per piece PU = 20	white	962-00	
		grey	-08	
		black	-57	
	ENDSTOPPER turnable for beginning and end of folding for LaOla gliderchain art. no. 966 Price € per piece PU = 20	white	967-00	
		grey	-08	
		black	-57	
	CURTAIN HOOK PU = 100	white	865-00	
		grey	-08	
		black	-57	
	GLIDERCHAIN-SET consisting of LaOla gliderchain turnable, 4 endstopper, curtain hooks and 2 drapery divider	white	up to 200 cm	966-1-00
		white	up to 300 cm	966-2-00
		white	up to 400 cm	966-3-00
		white	up to 500 cm	966-4-00
		white	up to 600 cm	966-5-00
		grey	up to 200 cm	966-1-08
		grey	up to 300 cm	966-2-08
		grey	up to 400 cm	966-3-08
		grey	up to 500 cm	966-4-08
		grey	up to 600 cm	966-5-08
black	up to 200 cm	966-1-57		
black	up to 300 cm	966-2-57		
black	up to 400 cm	966-3-57		
black	up to 500 cm	966-4-57		
black	up to 600 cm	966-5-57		

WITH CORDED SETS ON THE SAFE SIDE

As specialists in privacy screens, you and we are expected by our end customers to provide a compliant design in terms of child safety. As this is of paramount importance, the previous legal situation has been expanded at EU level, turning the ‚may’ regulation into a clear requirement that will be in effect from 2014.

SAFE INSTALLATION

Small children can become strangled in cord loops. Depending on the system, this danger should be eliminated either by a control loop with a tear-off system or by a fixation point on the wall. Loops with pull cords must be attached to the wall at a minimum height of 150 cm (see illustration) above the floor to prevent them from tearing.

RESPONSIBILITY

Our products are produced and labeled in accordance with applicable standards and laws. It is the responsibility of the installer to inform the end user of any risks and to ensure proper measurement and installation. Please send us the completed form signed by the end user (your customer) confirming that you have instructed the end user in the operation of the installed Corded Set and have explained the requirements for child safety installation and operation of the system.

WARNING

Small children can become strangled in the loops of cords, chains, tapes, pull cords, and cords used to operate window coverings.

Cords should be kept out of the reach of children to prevent strangulation and entanglement. They can also wrap around the neck. Beds, cribs, and furniture should be placed away from window treatment cords. Do not tie cords together.

Make sure the cords do not twist and form a loop.

Warning in accordance with DIN EN 13120



Additional information on child safety can be found on the website of ViS, the Association for Interior Window and Sun Protection

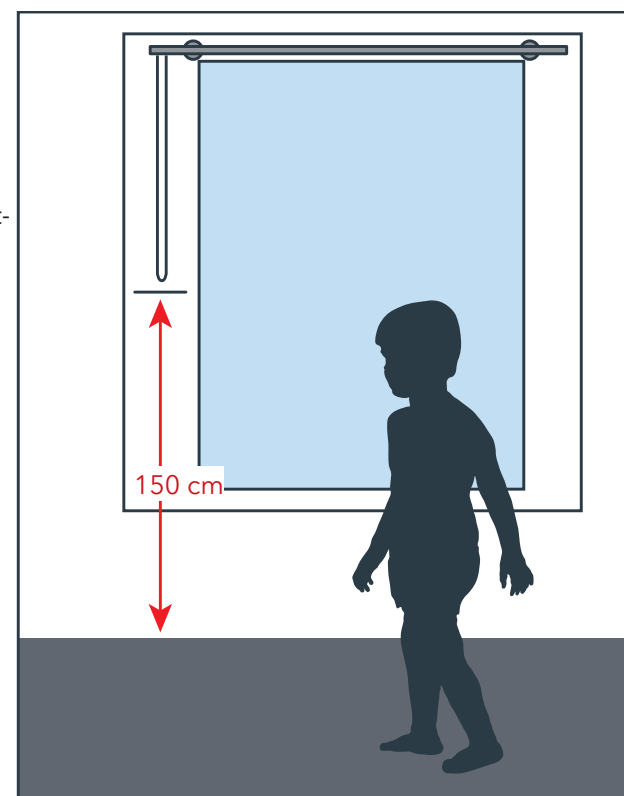













Illustration: Corded set

Motors

OVERVIEW

	POWERED by 				
	Movelite 35 WireFree RTS 	Irismo 45 WireFree RTS 	Glydea Ultra 60e RTS 	Shuttle M 	Shuttle iOn 
Image					
Article-No.	11692-35-00	11690-00	11691-60-00	11681-24-00	11682-14-00
Max. weight of the curtain	35 kg	45 kg	60 kg	70 kg	25 kg
Dimensions	27,8 x 9,3 x 5,2 cm	30,8 x 9,3 x 5,2 cm	31,6 x 9,3 x 5,2 cm	23 x 5 x 7 cm	32 x 5 x 7 cm
Power supply	14,8 V	26,5 V Li-Ion	220 V AC 50/60 HZ	24 V	14,8 V DC
Power output	35 W	45 W	120 W	65 W	30 W
Velocity	15 cm/sec.	12,5 cm/sec. - 20 cm/sec.	12,5 cm/sec. - 20 cm/sec.	14,0 cm/sec. - 17,0 cm/Sec.	14,0 cm/sec. - 17,0 cm/sec.
Motors weight	1040 g	1434 g	1338 g	930 g	1160 g
Torque	0,6 Nm	0,8 Nm	1,0 Nm	1,5 Nm	1,0 Nm
Sound level	41 dBA	< 44 dBa	< 44 dBa	< 40 dBa	< 40 dBa
Touch Control Technology	✓	✓	✓	✓	✓
Soft start	✓	✓	✓	✓	✓
Soft stop	✓	✓	✓	✓	✓

BÜSCHE

TECDOR IQ-Series

Pur IQ - Motorized Pole Sets

32 x 46 mm

satined nickel

Pole set no. **19-32462-29**



Finishes:



-08 sat. aluminium



-22 polished chrome

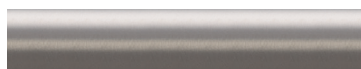

-29 satined nickel



-48 white matt



-157 black matt



-209 brushed gold



-850 brushed palladium





somfy IRISMO WIREFREE 45 RTS EU WIRAT
74300-France
400 is 3.0m, 1.0m ON, 2.0m OFF, 3.0m UP, 1.0m DOWN
Power adapter output: 24 VDC
1000528
Made in China
For more info: www.somfy.com

somfy

somfy



GERMAN
DESIGN
AWARD
SPECIAL
2022

Pur IQ 32 x 46 mm

WALL- AND CEILING INSTALLATION / 32 X 46 mm / SINGLE RAIL



Pur IQ - satin nickel - Page 46 - Pole set no. 12-32465-29



FINISHES AVAILABLE



-08 sat. aluminium



-22 polished chrome

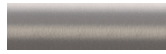

-29 satined nickel



-48 white matt



-157 black matt



-209 brushed gold



-850 brushed palladium

Illustrations on a scale of 1 : 1





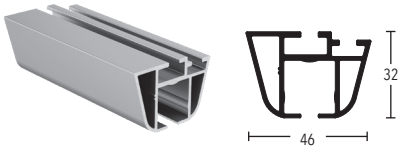
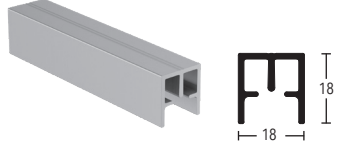
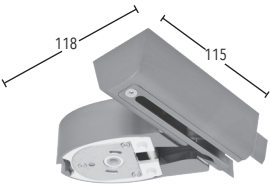
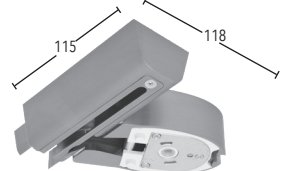
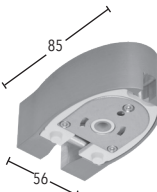
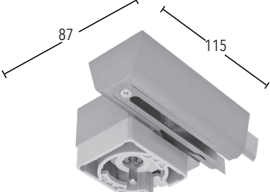
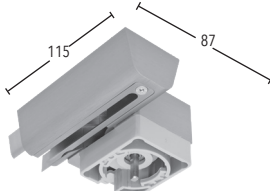
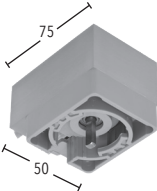

Pur IQ 32 x 46 mm Accessories

	ARTICLE	FINISH	ARTICLE-NO.		
	ALUMINIUM RAIL PUR 32 x 46 mm Standard length of 6 m	sat. aluminium polished chrome satined nickel white matt black matt brushed gold brushed palladium	8223246-08 -22 -29 -48 -157 -209 -850	Fix length (cut to size)	Standard length
	ALUMINIUM-INSERT-RAIL required for motorized pole sets Standard length of 6 m Note: mandatory for each system	silver black	8221818-108 -157	Fix length (cut to size)	Standard length
	PULLEY HOUSING PUR, LEFT for rail art. no. 8223246 fits for Somfy motor art. no. 11690-00, 11691-60-00 and 11692-35-00 PU = 1	sat. aluminium polished chrome satined nickel white matt black matt brushed gold brushed palladium	11699-L-46-08 -22 -29 -48 -157 -209 -850		
	PULLEY HOUSING PUR, RIGHT for rail art. no. 8223246 fits for Somfy motor art. no. 11690-00, 11691-60-00 and 11692-35-00 PU = 1	sat. aluminium polished chrome satined nickel white matt black matt brushed gold brushed palladium	11699-R-46-08 -22 -29 -48 -157 -209 -850		
	PULLEY HOUSING PUR AHEAD for rail art. no. 8223246 fits for Somfy motor art. no. 11690-00, 11691-60-00 and 11692-35-00 PU = 1	sat. aluminium polished chrome satined nickel white matt black matt brushed gold brushed palladium	11799-46-08 -22 -29 -48 -157 -209 -850		
	PULLEY HOUSING PUR, LEFT for rail art. no. 8223246 fits for Forest motor art. no. 11681-24-00 and 11682-14-00 PU = 1	sat. aluminium polished chrome satined nickel white matt black matt brushed gold brushed palladium	11679-L-46-08 -22 -29 -48 -157 -209 -850		
	PULLEY HOUSING PUR, RIGHT for rail art. no. 8223246 fits for Forest motor art. no. 11681-24-00 and 11682-14-00 PU = 1	sat. aluminium polished chrome satined nickel white matt black matt brushed gold brushed palladium	11679-R-46-08 -22 -29 -48 -157 -209 -850		
	PULLEY HOUSING PUR AHEAD for rail art. no. 8223246 fits for Forest motor art. no. 11681-24-00 and 11682-14-00 PU = 1	sat. aluminium polished chrome satined nickel white matt black matt brushed gold brushed palladium	11779-46-08 -22 -29 -48 -157 -209 -850		



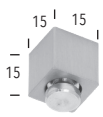
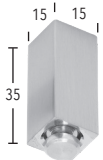
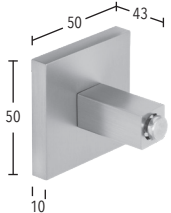
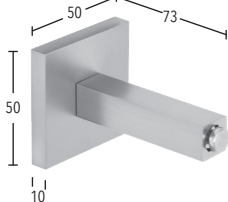
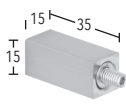

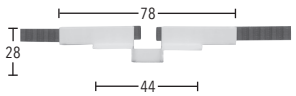

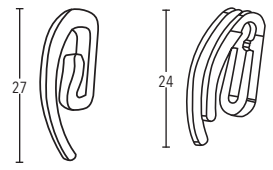

Pur IQ 32 x 46 mm Accessories

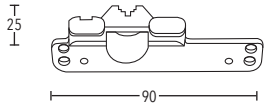
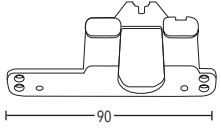
	ARTICLE	FINISH	ARTICLE-NO.
	RETURN PULLEY PUR, LEFT for redirection the transport belt for rail art. no. 8223246 PU = 1	sat. aluminium polished chrome satined nickel white matt black matt brushed gold brushed palladium	11683-L-46-08 -22 -29 -48 -157 -209 -850
	RETURN PULLEY PUR, RIGHT for redirection the transport belt for rail art. no. 8223246 PU = 1	sat. aluminium polished chrome satined nickel white matt black matt brushed gold brushed palladium	11683-R-46-08 -22 -29 -48 -157 -209 -850
	RETURN PULLEY PUR KURZ for redirection the transport belt for rail art. no. 8223246 PU = 1	sat. aluminium polished chrome satined nickel white matt black matt brushed gold brushed palladium	11686-46-08 -22 -29 -48 -157 -209 -850
	WALL BRACKET (System 0-) single, extension 90 mm for rail art. no. 8223246 PU = 6	sat. aluminium polished chrome satined nickel white matt black matt brushed gold brushed palladium	11260-90-08 -22 -29 -48 -157 -209 -850
	WALL BRACKET (System 1-) single, extension 130 mm for rail art. no. 8223246 PU = 6	sat. aluminium polished chrome satined nickel white matt black matt brushed gold brushed palladium	11260-130-08 -22 -29 -48 -157 -209 -850
	CEILING BRACKET 3 mm (System 13-) single, ceiling extension 32 mm for rails PU = 10	silver white black	11592-00 -28 -157
	CLAMPING CEILING BRACKET 3 mm (System 19-) single, ceiling extension 32 mm Material: plastic for rails PU = 10	white	11590-10-00
	CEILING BRACKET 3 mm (System 11-) including drill hole cover single, ceiling extension 32 mm for rails PU = 10	silver white black	11597-00 -28 -157
	CEILING BRACKET 15 mm (System 12-) single, ceiling extension 47 mm for rails PU = 10	sat. aluminium polished chrome satined nickel white matt black matt brushed gold brushed palladium	11473-100-08 -22 -29 -48 -157 -209 -850







Pur IQ 32 x 46 mm Accessories

	ARTICLE	FINISH	ARTICLE-NO.	
	CEILING BRACKET 15 mm (System 15-) single, ceiling extension 47 mm for rails PU = 10	sat. aluminium polished chrome satined nickel white matt black matt brushed gold brushed palladium	11473-15-08 -22 -29 -48 -157 -209 -850	
	CEILING BRACKET 35 mm (System 16-) single, ceiling extension 67 mm for rails PU = 10	sat. aluminium polished chrome satined nickel white matt black matt brushed gold brushed palladium	11473-35-08 -22 -29 -48 -157 -209 -850	
	CEILING BRACKET 43 mm (System 17-) single, ceiling extension 75 mm for rails PU = 6	sat. aluminium polished chrome satined nickel white matt black matt brushed gold brushed palladium	11473-50-08 -22 -29 -48 -157 -209 -850	
	CEILING BRACKET 73 mm single, ceiling extension 105 mm for rails PU = 6	sat. aluminium polished chrome satined nickel white matt black matt brushed gold brushed palladium	11473-80-08 -22 -29 -48 -157 -209 -850	
	EXTENSION (square) length 35 mm for all ceiling bracket art. no. 11473-35, 11473-50 and 11473-80 PU = 2	sat. aluminium polished chrome satined nickel white matt black matt brushed gold brushed palladium	11473-2/2-08 -22 -29 -48 -157 -209 -850	
	TRANSPORT BELT role 100 meters Price € per metre	green	8809-10-00	Fix length (cut to size)
	TRANSPORT BELT-CONNECTOR PU = 1	white	8809-16-00	
	GLIDER PU = 100	white gray black	8809-52-00 -08 -57	
	CURTAIN HOOK CURTAIN DOUBLE HOOK PU = 100	white white	869-00 853-00	

Pur IQ 32 x 46 mm Accessories

	ARTICLE	FINISH	ARTICLE-NO.
	MASTER CARRIER, UNDERLAP PU = 1	white gray black	8809-23-00 -08 -57
	MASTER CARRIER, OVERLAP PU = 1	white gray black	8809-24-00 -08 -57
	WAVE CARRIER PU = 1	white gray black	8809-34-00 -08 -57
	SOMFY DRIVE MOTOR (Battery) MoveLite 35 WireFree RTS incl. battery and USB-charging cable PU = 1 ATTENTION: Please note the different purchasing conditions	white	11692-35-00
	TRANSFORMATOR for USB-Cable for Somfy drive motor MoveLite35 art. no. 11692-35-00 PU = 1 ATTENTION: Please note the different purchasing conditions	black	11692-6-57
	SOMFY DRIVE MOTOR (Battery) Irismo 45 WireFree RTS incl. battery PU = 1 ATTENTION: Please note the different purchasing conditions	white	11690-00
	CHARGING CABLE WITH POWER SUPPLY UNIT for drive motor Somfy Irismo art. no. 11690-00 PU = 1 ATTENTION: Please note the different purchasing conditions	white	11690-6-00
	SOMFY DRIVE MOTOR Glydea Ultra 60e RTS Power supply 100 V - 240 V PU = 1 ATTENTION: Please note the different purchasing conditions	white	11691-60-00
	SOMFY REMOTE CONTROL, 5-CHANNEL for all Somfy drive motors PU = 1 ATTENTION: Please note the different purchasing conditions	white	11690-5-00

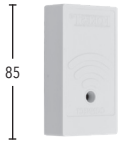
Pur IQ 32 x 46 mm Accessories

	ARTICLE	FINISH	ARTICLE-NO.
	FOREST SHUTTLE iOn MOTOR (Battery) incl. battery PU = 1 ATTENTION: Please note the different purchasing conditions	white black	11682-14-00 -57
	CHARGING CABLE WITH POWER SUPPLY UNIT for drive motor Shuttle iOn art. no. 11682-14-00 PU = 1 ATTENTION: Please note the different purchasing conditions	black	11682-15-57
	FOREST SHUTTLE DRIVE MOTOR PU = 1 ATTENTION: Please note the different purchasing conditions	white gray black	11681-24-00 -08 -57
	TRANSFORMATOR 24 V -SHUTTLE with connection cable and holder - EUROPA for drive motor 24 V art. no. 11681-24-00 PU = 1 ATTENTION: Please note the different purchasing conditions	white	11681-3-00
	FOREST REMOTE CONTROL, 6-CHANNEL for all Shuttle drive motors PU = 1 ATTENTION: Please note the different purchasing conditions	white black	11681-8-00 -57
	FOREST WIFI DONGLE for drive motor Shuttle 24V art. no. 11681-24 enables control via the Forest Connect app PU = 1 ATTENTION: Please note the different purchasing conditions	white black	11680-10-00 -57
	FOREST WLAN POWER SOCKET incl. connector and accessories for Shuttle iOn drive motor art. no. 11682-14 and Suttle 24V art. no. 11681-14 enables control via the Forest Connect app PU = 1 ATTENTION: Please note the different purchasing conditions	white	11680-13-00

Pur IQ 32 x 46 mm Illustrations

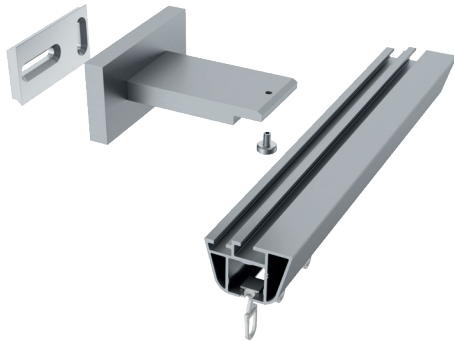

Wall bracket
art. no. 11260-90

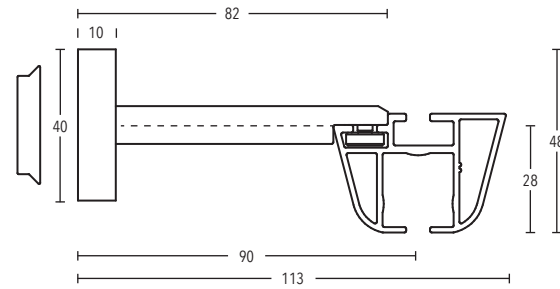

Wall bracket
art. no. 11260-130

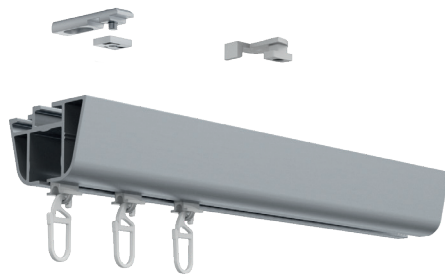
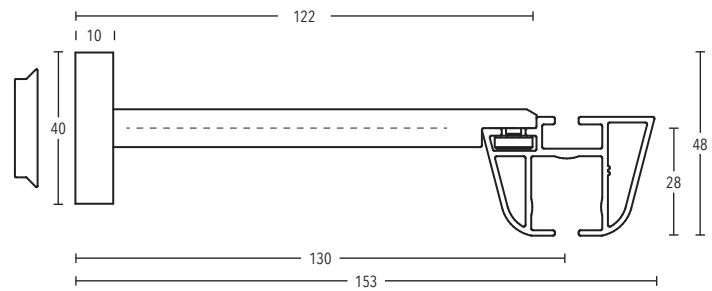

Clamping ceiling bracket
art. no. 11590-10-00

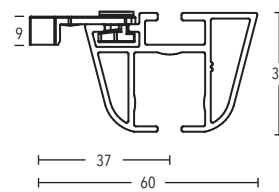

Ceiling bracket 3 mm
art. no. 11592

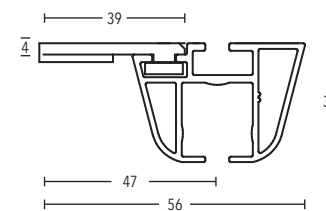

Ceiling bracket 3 mm
art. no. 11597

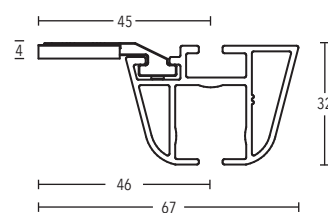

Pur IQ 32 x 46 mm Illustrations

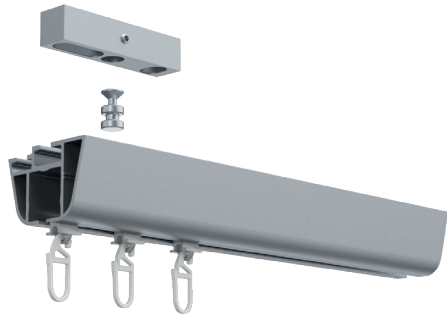

Ceiling bracket 15 mm
art. no. 11473-100

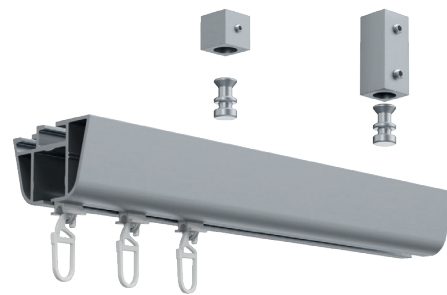
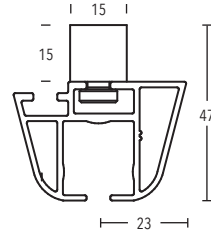

Ceiling bracket 15 mm + 35 mm
art. no. 11473-15 + 11473-35

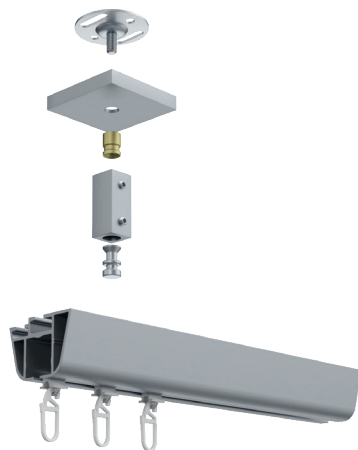
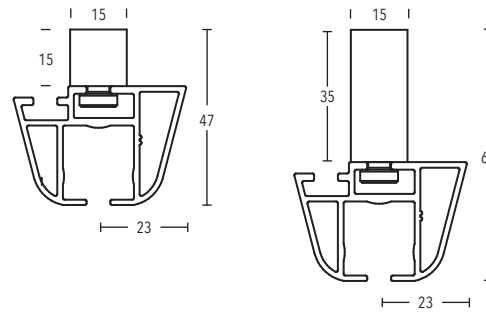

Ceiling bracket 43 mm + 73 mm
art. no. 11473-50 + 11473-80

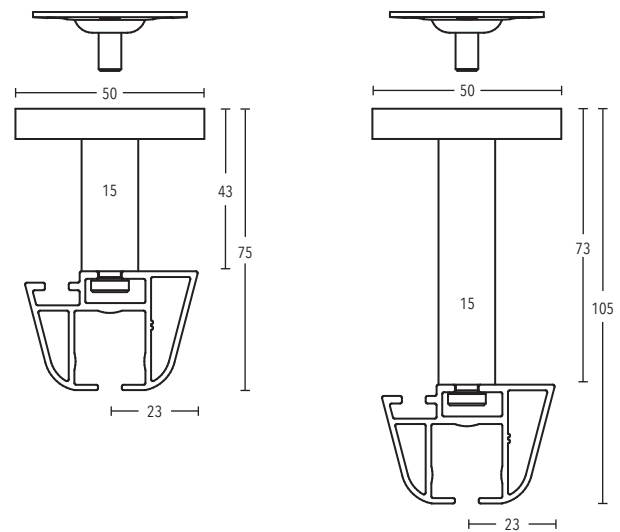

BÜSCHE

TECDOR IQ-Series

Cos IQ - Motorized Pole Sets

32 x 53 mm

white matt

Pole set no. 1-32532-48



Finishes:



-29 satined nickel



-48 white matt



-157 black matt





Cos IQ 32 x 53 mm

WALL- AND CEILING INSTALLATION / 32 X 53 mm / SINGLE RAIL



Cos IQ - black matt - Page 70 - Pole set no. 15-32535-157

FINISHES AVAILABLE

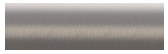

-29 satined nickel



-48 white matt



-157 black matt

Illustrations on a scale of 1 : 1

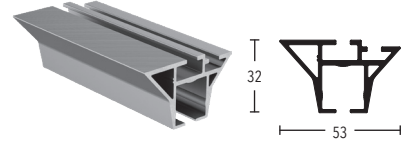
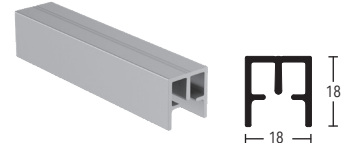
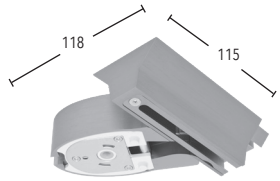
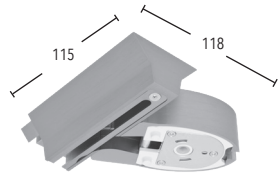
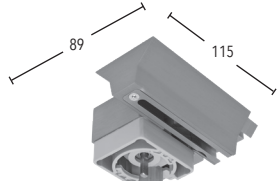
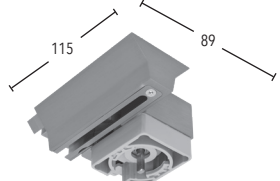
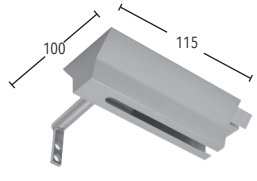
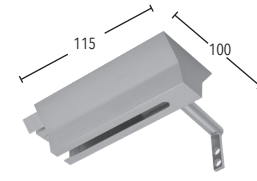

Cos IQ 32 x 53 mm Accessories

	ARTICLE	FINISH	ARTICLE-NO.		
 <p>32 x 53 mm Standard length of 6 m</p>	ALUMINIUM RAIL COS 32 x 53 mm Standard length of 6 m	satined nickel white matt black matt	8223253-29 -48 -157	Fix length (cut to size)	Standard length
 <p>18 x 18 mm</p>	ALUMINIUM-EINSCHUB-RAIL Note: mandatory for motorized system Standard length of 6 m	silver black	8221818-108 -157	Fix length (cut to size)	Standard length
 <p>118 x 115 mm</p>	PULLEY HOUSING COS, LEFT for rail art. no. 8223253 fits for Somfy motor art. no. 11690-00, 11691-60-00 and 11692-35-00	satined nickel white matt black matt	11699-L-53-29 -48 -157	Fix length (cut to size)	Standard length
 <p>118 x 115 mm</p>	PULLEY HOUSING COS, RIGHT for rail art. no. 8223253 fits for Somfy motor art. no. 11690-00, 11691-60-00 and 11692-35-00	satined nickel white matt black matt	11699-R-53-29 -48 -157	Fix length (cut to size)	Standard length
 <p>115 x 89 mm</p>	PULLEY HOUSING COS, LEFT for rail art. no. 8223253 fits for Forest motor art. no. 11681-24-00 and art. no. 11682-14-00	satined nickel white matt black matt	11679-L-53-29 -48 -157	Fix length (cut to size)	Standard length
 <p>115 x 89 mm</p>	PULLEY HOUSING COS, RIGHT for rail art. no. 8223253 fits for Forest motor art. no. 11681-24-00 and art. no. 11682-14-00	satined nickel white matt black matt	11679-R-53-29 -48 -157	Fix length (cut to size)	Standard length
 <p>115 x 100 mm</p>	RETURN PULLEY COS, LEFT for redirection the transport belt for rail art. no. 8223253	satined nickel white matt black matt	11683-L-53-29 -48 -157	Fix length (cut to size)	Standard length
 <p>115 x 100 mm</p>	RETURN PULLEY COS, RIGHT for redirection the transport belt for rail art. no. 8223253	satined nickel white matt black matt	11683-R-53-29 -48 -157	Fix length (cut to size)	Standard length



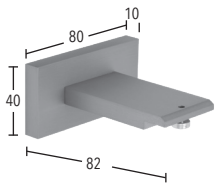
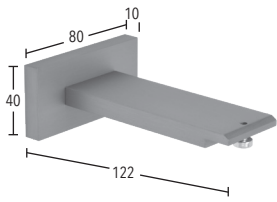
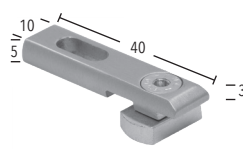
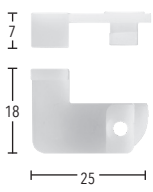
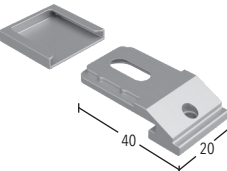
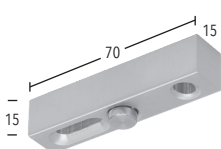
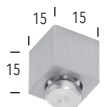
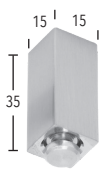



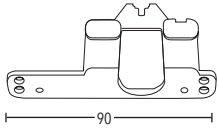

Cos IQ 32 x 53 mm Accessories

	ARTICLE	FINISH	ARTICLE-NO.
	WALL BRACKET COS (System 0-) single, wall extension 90 mm for rail art. no. 8223253 PU = 6	satined nickel white matt black matt	11260-90-29 -48 -157
	WALL BRACKET COS (System 1-) single, wall extension 130 mm for rail art. no. 8223253 PU = 6	satined nickel white matt black matt	11260-130-29 -48 -157
	CEILING BRACKET 3 mm (System 13-) single, ceiling extension 32 mm for rails PU = 10	silver white black	11592-00 -28 -157
	CLAMPING CEILING BRACKET 3 mm (System 19-) single, ceiling extension 32 mm for rails PU = 10	white	11590-10-00
	CEILING BRACKET 3 mm (System 11-) single, ceiling extension 32 mm for rails PU = 10	silver white black	11597-00 -28 -157
	CEILING BRACKET 15 mm (System 12-) single, ceiling extension 47 mm for rails PU = 10	satined nickel white matt black matt	11473-100-29 -48 -157
	CEILING BRACKET 15 mm (System 15-) single, ceiling extension 47 mm for rails PU = 10	satined nickel white matt black matt	11473-15-29 -48 -157
	CEILING BRACKET 35 mm (System 16-) single, ceiling extension 67 mm for rails PU = 10	satined nickel white matt black matt	11473-35-29 -48 -157

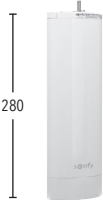



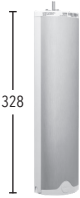

Cos IQ 32 x 53 mm Accessories

	ARTICLE	FINISH	ARTICLE-NO.	
	CEILING BRACKET 43 mm (System 17-) single, ceiling extension 75 mm for rails PU = 6	satined nickel white matt black matt	11473-50-29 -48 -157	
	CEILING BRACKET 73 mm single, ceiling extension 105 mm for rails PU = 6	satined nickel white matt black matt	11473-80-29 -48 -157	
	EXTENSION (square) length 35 mm for all ceiling bracket art. no. 11473-35, 11473-50 and 11473-80 PU = 2	satined nickel white matt black matt	11473-2/2-29 -48 -157	
	TRANSPORT BELT role 100 meters Price € per metre	green	8809-10-00	Fix length (cut to size)
	TRANSPORT BELT-CONNECTOR PU = 1	white	8809-16-00	
	GLIDER PU = 100	white gray black	8809-52-00 -08 -57	
	CURTAIN HOOK CURTAIN DOUBLE HOOK PU = 100	white white	869-00 853-00	
	MASTER CARRIER, UNDERLAP PU = 1	white gray black	8809-23-00 -08 -57	

Cos IQ 32 x 53 mm Accessories

	ARTICLE	FINISH	ARTICLE-NO.
	MASTER CARRIER, OVERLAP PU = 1	white gray black	8809-24-00 -08 -57
	WAVE CARRIER PU = 1	white gray black	8809-34-00 -08 -57
	SOMFY DRIVE MOTOR (Battery) MoveLite 35 WireFree RTS incl. battery and USB-charging cable PU = 1 ATTENTION: Please note the different purchasing conditions	white	11692-35-00
	TRANSFORMATOR for USB-Cable for Somfy drive motor MoveLite35 Art.-No. 11692-35-00 PU = 1 ATTENTION: Please note the different purchasing conditions	black	11692-6-57
	SOMFY DRIVE MOTOR (Battery) Irismo 45 WireFree RTS incl. battery PU = 1 ATTENTION: Please note the different purchasing conditions	white	11690-00
	CHARGING CABLE WITH POWER SUPPLY UNIT for drive motor Somfy Irismo Art.-No. 11690-00 PU = 1 ATTENTION: Please note the different purchasing conditions	white	11690-6-00
	SOMFY DRIVE MOTOR Glydea Ultra 60e RTS Power supply 100 V - 240 V PU = 1 ATTENTION: Please note the different purchasing conditions	white	11691-60-00
	SOMFY REMOTE CONTROL, 5-CHANNEL for all Somfy drive motors PU = 1 ATTENTION: Please note the different purchasing conditions	white	11690-5-00

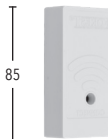
Cos IQ 32 x 53 mm Accessories

	ARTICLE	FINISH	ARTICLE-NO.
	FOREST SHUTTLE iOn-MOTOR (Battery) incl. battery PU = 1 ATTENTION: Please note the different purchasing conditions	white black	11682-14-00 -57
	CHARGING CABLE WITH POWER SUPPLY UNIT for drive motor Shuttle iOn Art.-No. 11682-14-00 PU = 1 ATTENTION: Please note the different purchasing conditions	black	11682-15-57
	FOREST SHUTTLE DRIVE MOTOR PU = 1 ATTENTION: Please note the different purchasing conditions	white gray black	11681-24-00 -08 -57
	TRANSFORMATOR 24 V -SHUTTLE with connection cable and holder - EUROPA for drive motor 24 V Art.-No. 11681-24-00 PU = 1 ATTENTION: Please note the different purchasing conditions	white	11681-3-00
	FOREST REMOTE CONTROL, 6-CHANNEL for all Shuttle drive motors PU = 1 ATTENTION: Please note the different purchasing conditions	white black	11681-8-00 -57
	FOREST WIFI DONGLE for drive motor Shuttle 24V Art.-No. 11681-14 enables control via the Forest Connect app PU = 1 ATTENTION: Please note the different purchasing conditions	white black	11680-10-00 -57
	FOREST WLAN POWER SOCKET incl. connector and accessories for Shuttle iOn drive motor Art.-No. 11682-15 and Suttle 24V Art.-No. 11681-14 enables control via the Forest Connect app PU = 1 ATTENTION: Please note the different purchasing conditions	white	11680-13-00

Cos IQ 32 x 53 mm Illustrations

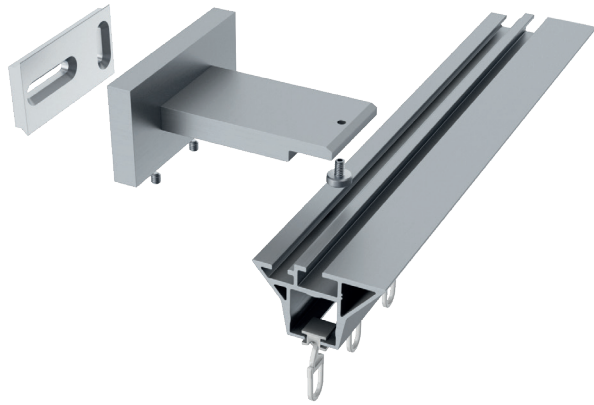

Wall bracket
Art.-No. 11260-90

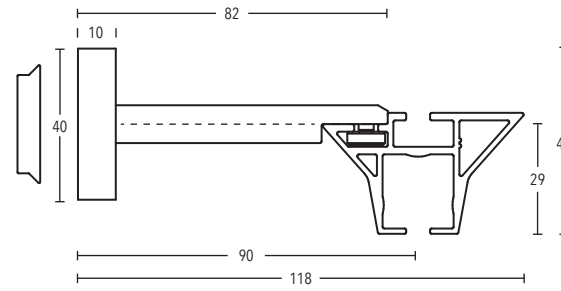

Wall bracket
Art.-No. 11260-130

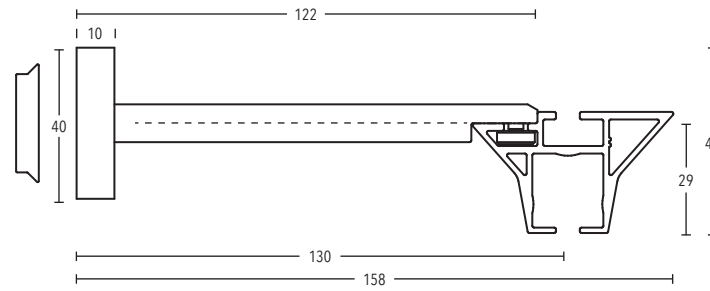

Ceiling bracket 3 mm
Art.-No. 11592-00

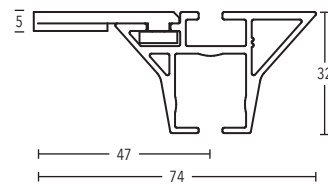

Ceiling bracket 3 mm
Art.-No. 11597-00

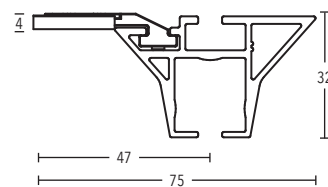

Cos IQ 32 x 53 mm Illustrations



Ceiling bracket 15 mm
Art.-No. 11473-100

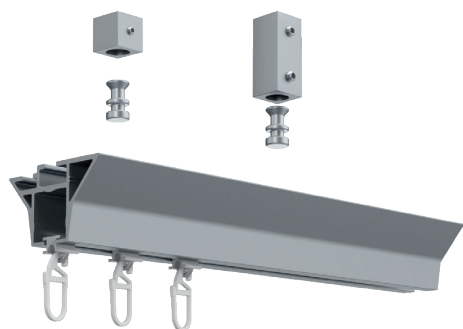
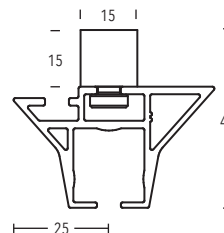

Ceiling bracket 15 mm + 35 mm
Art.-No. 11473-15 + 11473-35

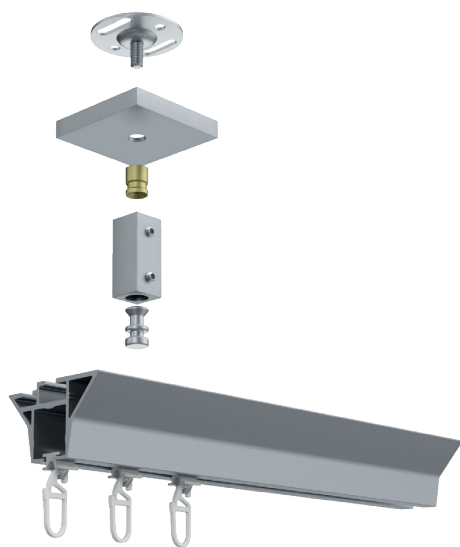
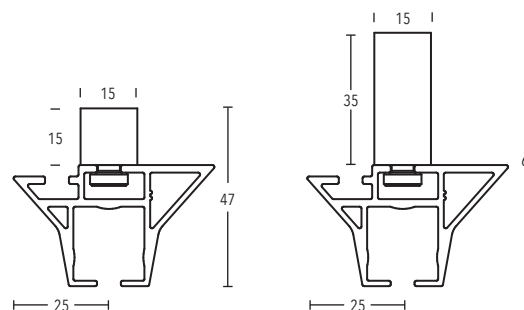

Ceiling bracket 43 mm + 73 mm
Art.-No. 11473-50 + 11473-80

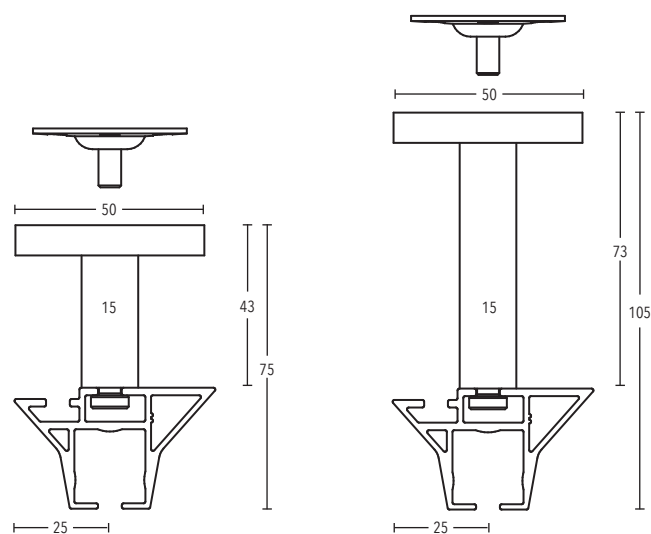

BÜSCHE

TECDOR IQ-Series

Lep IQ - Motorized Pole Sets

31 x 90 mm

satined nickel

Pole set no. **10-31902-29**



Finishes:

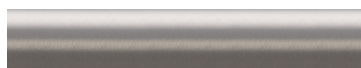

-29 satined nickel



-157 black matt



-209 brushed gold



-850 brushed palladium

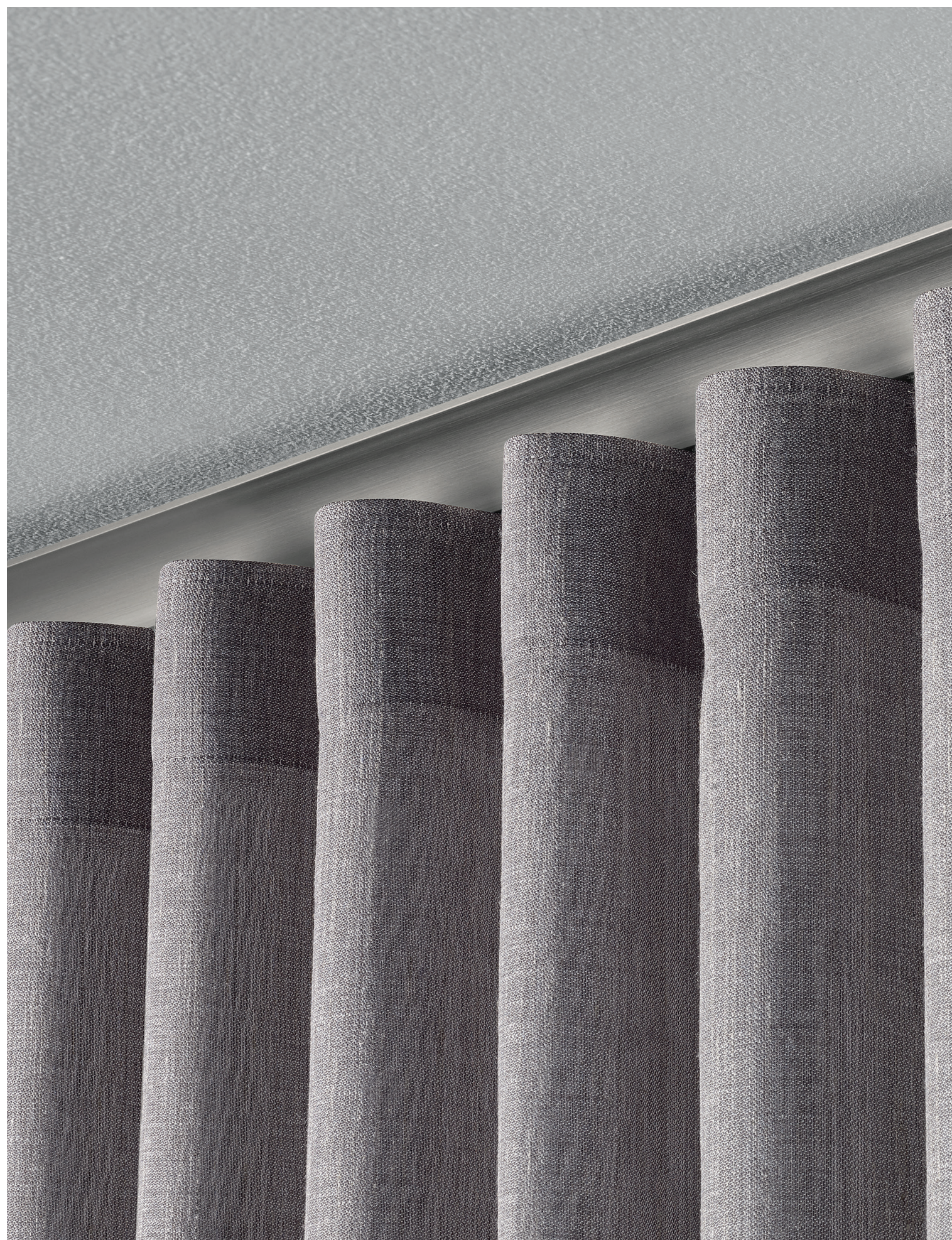



Lep IQ 31 x 90 mm

WALL- AND CEILING INSTALLATION / 31 X 90 MM / SINGLE RAIL



Lep IQ - brushed palladium - Page 86 - Pole set no. 12-31902-850

FINISHES AVAILABLE

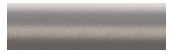

-29 satined nickel



-157 black matt



-209 brushed gold



-850 brushed palladium

Illustrations on a scale of 1 : 1



Lep IQ



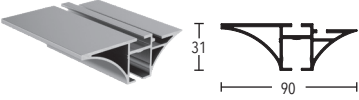
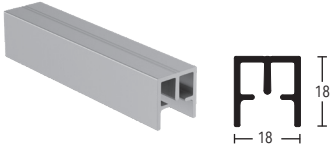
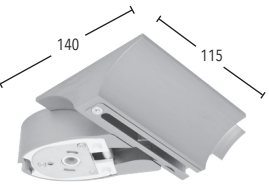
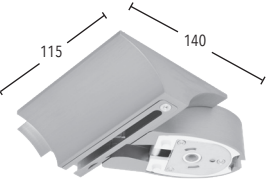
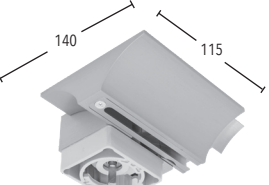
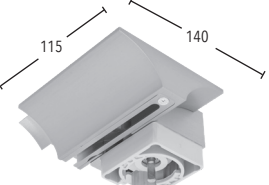
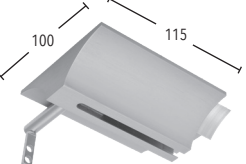
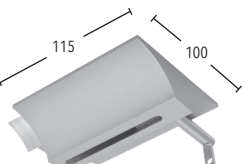

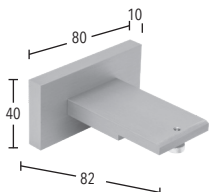
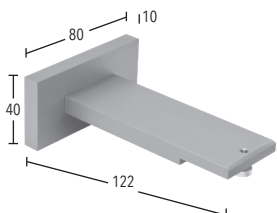
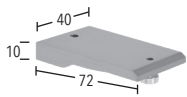
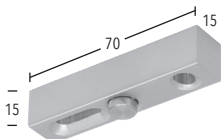
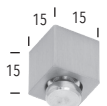
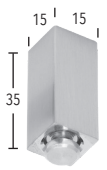
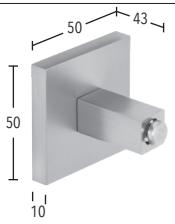
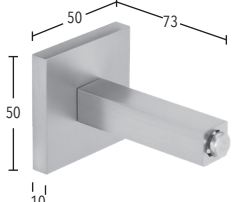

Lep IQ 31 x 90 mm Accessories

	ARTICLE	FINISH	ARTICLE NO.		
	ALUMINIUM-RAIL LEP 31 x 90 mm Standard length of 6 m	satined nickel black matt brushed gold brushed palladium	8223190-29 -157 -209 -850	Fix length (cut to size)	Standard length
	ALUMINIUM-INSERT-RAIL required for motorized pole sets Standard length of 6 m Note: mandatory for each system	silver black	8221818-108 -157	Fix length (cut to size)	Standard length
	PULLEY HOUSING LEP, LEFT for rail art. no. 8223190 fits for Somfy motor art.-no. 11690-00, 11691-60-00 und 11692-35-00 PU = 1	satined nickel black matt brushed gold brushed palladium	11699-L-90-29 -157 -209 -850		
	PULLEY HOUSING LEP, RIGHT for rail art. no. 8223190 fits for Somfy motor art.-no. 11690-00, 11691-60-00 und 11692-35-00 PU = 1	satined nickel black matt brushed gold brushed palladium	11699-R-90-29 -157 -209 -850		
	PULLEY HOUSING LEP, LEFT for rail art. no. 8223190 fits for Forest motor art.-no. 11681-24-00 und 11682-14-00 PU = 1	satined nickel black matt brushed gold brushed palladium	11679-L-90-29 -157 -209 -850		
	PULLEY HOUSING LEP, RIGHT for rail art. no. 8223190 fits for Forest motor art.-no. 11681-24-00 und 11682-14-00 PU = 1	satined nickel black matt brushed gold brushed palladium	11679-R-90-29 -157 -209 -850		
	RETURN PULLEY LEP, LEFT for redirection the transport belt for rail art. no. 8223190 PU = 1	satined nickel black matt brushed gold brushed palladium	11683-L-90-29 -157 -209 -850		
	RETURN PULLEY LEP, RIGHT for redirection the transport belt for rail art. no. 8223190 PU = 1	satined nickel black matt brushed gold brushed palladium	11683-R-90-29 -157 -209 -850		



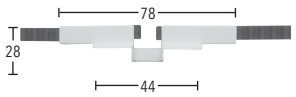

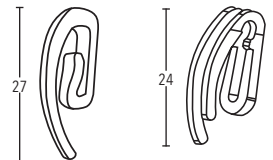
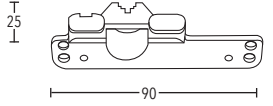
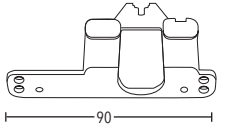

Lep IQ 31 x 90 mm Accessories

	ARTICLE	FINISH	ARTICLE NO.
	WALL BRACKET LEP (System 0-) single, wall extension 90 mm for rail art. no. 8223190 PU = 6	satined nickel black matt brushed gold brushed palladium	11220-90-29 -157 -209 -850
	WALL BRACKET LEP (System 1-) single, wall extension 130 mm for rail art. no. 8223190 PU = 6	satined nickel black matt brushed gold brushed palladium	11220-130-29 -157 -209 -850
	CEILING BRACKET LEP 5 mm (System 10-) single, ceiling extension 32 mm for rail art. no. 8223190 PU = 10	satined nickel black matt brushed gold brushed palladium	11220-20-29 -157 -209 -850
	CEILING BRACKET 15 mm (System 12-) single, ceiling extension 46 mm for rails PU = 10	satined nickel black matt brushed gold brushed palladium	11473-100-29 -157 -209 -850
	CEILING BRACKET 15 mm (System 15-) single, ceiling extension 46 mm for rails PU = 10	satined nickel black matt brushed gold brushed palladium	11473-15-29 -157 -209 -850
	CEILING BRACKET 35 mm (System 16-) single, ceiling extension 66 mm for rails PU = 10	satined nickel black matt brushed gold brushed palladium	11473-35-29 -157 -209 -850
	CEILING BRACKET 43 mm (System 17-) single, ceiling extension 74 mm for rails PU = 6	satined nickel black matt brushed gold brushed palladium	11473-50-29 -157 -209 -850
	CEILING BRACKET 73 mm single, ceiling extension 104 mm for rails PU = 6	satined nickel black matt brushed gold brushed palladium	11473-80-29 -157 -209 -850



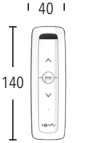

Lep IQ 31 x 90 mm Accessories

	ARTICLE	FINISH	ARTICLE NO.		
	EXTENSION (square) length 35 mm for all ceiling bracket art. no. 11473-35, 11473-50 and 11473-80 PU = 2	satined nickel black matt brushed gold brushed palladium	11473-2/2-29 -157 -209 -850		
	TRANSPORT BELT role 100 meters PU = 1	green	8809-10-00	Fix length (cut to size)	Role
	TRANSPORT BELT-CONNECTOR PU = 1	white	8809-16-00		
	GLIDER PU = 100	white grey black	8809-52-00 -08 -57		
	CURTAIN HOOK CURTAIN DOUBLE HOOK PU = 100	white white	869-00 853-00		
	MASTER CARRIER, UNDERLAP PU = 1	white grey black	8809-23-00 -08 -57		
	MASTER CARRIER, OVERLAP PU = 1	white grey black	8809-24-00 -08 -57		
	WAVE CARRIER PU = 1	white grey black	8809-34-00 -08 -57		

Lep IQ 31 x 90 mm Accessories

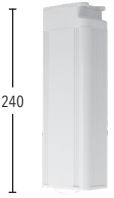
	ARTICLE	FINISH	ARTICLE NO.
 <p>280</p>	SOMFY DRIVE MOTOR (Battery) MoveLite 35 WireFree RTS incl. battery and USB-charging cable PU = 1 ATTENTION: Please note the different purchasing conditions	white	11692-35-00
	TRANSFORMATOR for USB-Cable for Somfy drive motor MoveLite35 art. no. 11692-35-00 PU = 1 ATTENTION: Please note the different purchasing conditions	black	11692-6-57
 <p>210 100</p>	SOMFY DRIVE MOTOR (Battery) Irismo 45 WireFree RTS incl. battery PU = 1 ATTENTION: Please note the different purchasing conditions	white	11690-00
	CHARGING CABLE WITH POWER SUPPLY UNIT for drive motor Somfy Irismo art. no. 11690-00 PU = 1 ATTENTION: Please note the different purchasing conditions	white	11690-6-00
 <p>328</p>	SOMFY DRIVE MOTOR Glydea Ultra 60e RTS Power supply 100 V - 240 V PU = 1 ATTENTION: Please note the different purchasing conditions	white	11691-60-00
 <p>40 140</p>	SOMFY REMOTE CONTROL, 5-CHANNEL for all Somfy drive motors PU = 1 ATTENTION: Please note the different purchasing conditions	white	11690-5-00
 <p>318</p>	FOREST SHUTTLE iOn-MOTOR (Battery) incl. battery PU = 1 ATTENTION: Please note the different purchasing conditions	white black	11682-14-00 -57
	CHARGING CABLE WITH POWER SUPPLY UNIT for drive motor Shuttle iOn art. no. 11682-14-00 PU = 1 ATTENTION: Please note the different purchasing conditions	black	11682-15-57

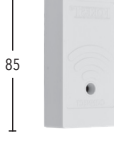
Lep IQ 31 x 90 mm Accessories

	ARTICLE	FINISH	ARTICLE NO.
 <p>240</p>	FOREST SHUTTLE DRIVE MOTOR PU = 1 ATTENTION: Please note the different purchasing conditions	white grey black	11681-24-00 -08 -57
	TRANSFORMATOR 24 V -SHUTTLE with connection cable and holder - EUROPA for drive motor 24 V art. no. 11681-24-00 PU = 1 ATTENTION: Please note the different purchasing conditions	white	11681-3-00
 <p>140</p>	FOREST REMOTE CONTROL, 6-CHANNEL for all Shuttle drive motors PU = 1 ATTENTION: Please note the different purchasing conditions	white black	11681-8-00 -57
 <p>85</p>	FOREST WIFI DONGLE for drive motor Shuttle 24V art. no. 11681-24 enables control via the Forest Connect app PU = 1 ATTENTION: Please note the different purchasing conditions	white black	11680-10-00 -57
	FOREST WLAN POWER SOCKET incl. connector and accessories for Shuttle iOn drive motor art. no. 11682-14 and Suttle 24V art. no. 11681-14 enables control via the Forest Connect app PU = 1 ATTENTION: Please note the different purchasing conditions	white	11680-13-00

Lep IQ 31 x 90 mm Illustrations



Ceiling bracket 5 mm
art. no. 11220-20

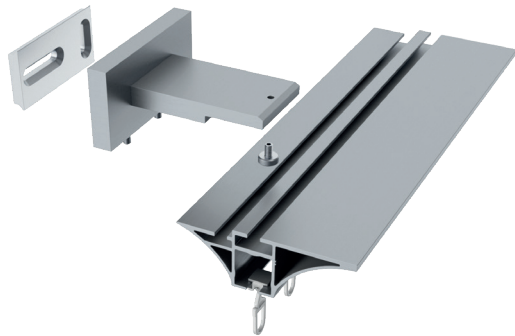
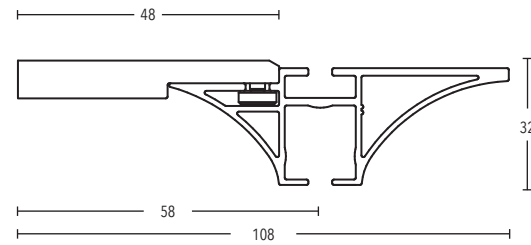

Wall bracket
art. no. 11220-90

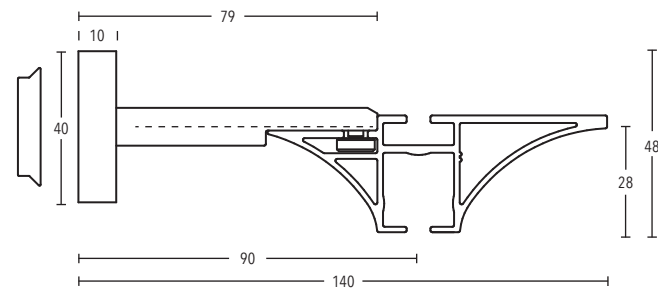

Wall bracket
art. no. 11220-130

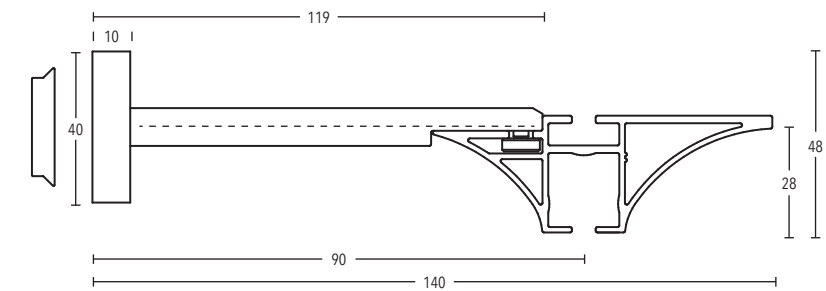

Ceiling bracket 15 mm
art. no. 11473-100

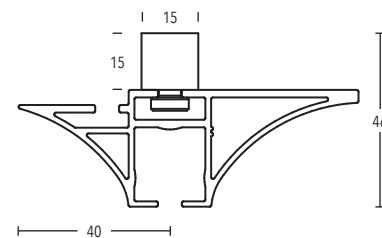

Lep IQ 31 x 90 mm Illustrations



Ceiling bracket 15 mm + 35 mm
art. no. 11473-15 + 11473-35

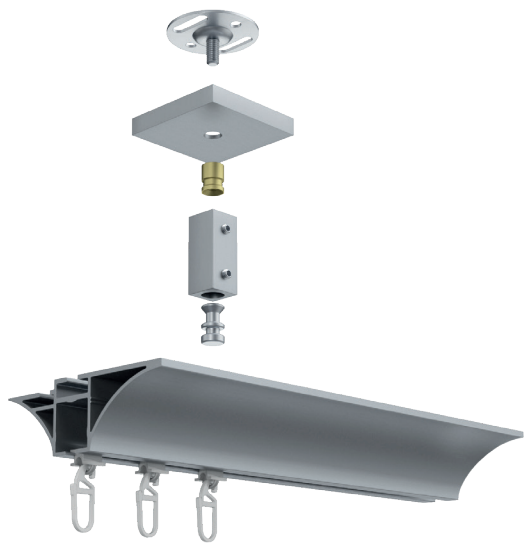
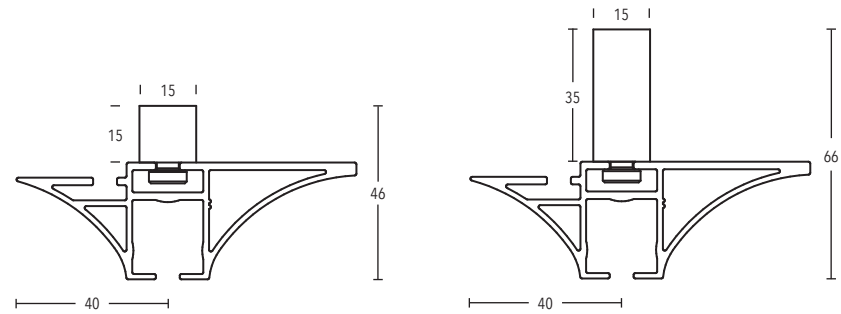

Ceiling bracket 43 mm and 73 mm
art. no. 11473-50 und 11473-80

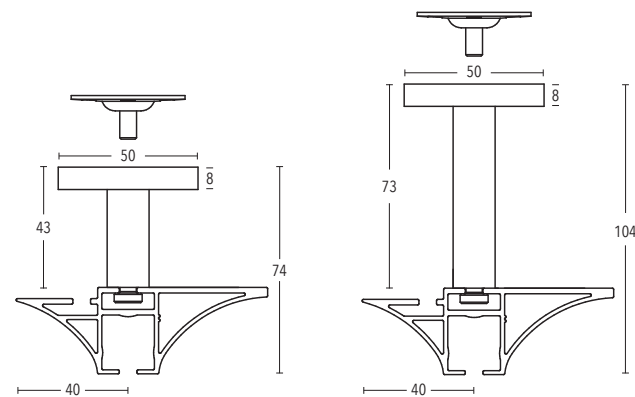

BÜSCHE

TECDOR IQ-Series

Ø 28 IQ - Motorized Pole Sets

Ø 28 mm

polished chrome

Pole set no. **4-28212-22**



Finishes:



-22 polished chrome



-29 satined nickel



-157 black matt





Ø 28 mm IQ

WALL- AND CEILING INSTALLATION / Ø 28 mm / SINGLE/DOUBLE RAIL

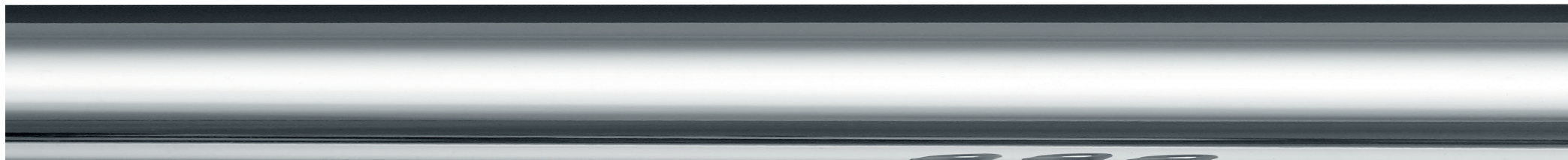

Ø 28 mm IQ - polished chrome - Page 104 - Pole set no. 4-28212-22



Ø 28 mm IQ - satined nickel - Page 106 - Pole set no. 15-28205-29



AVAILABLE FINISHES



-22 polished chrome

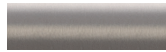

-29 satin nickel



-157 black matt



Illustrations on a scale of 1 : 1



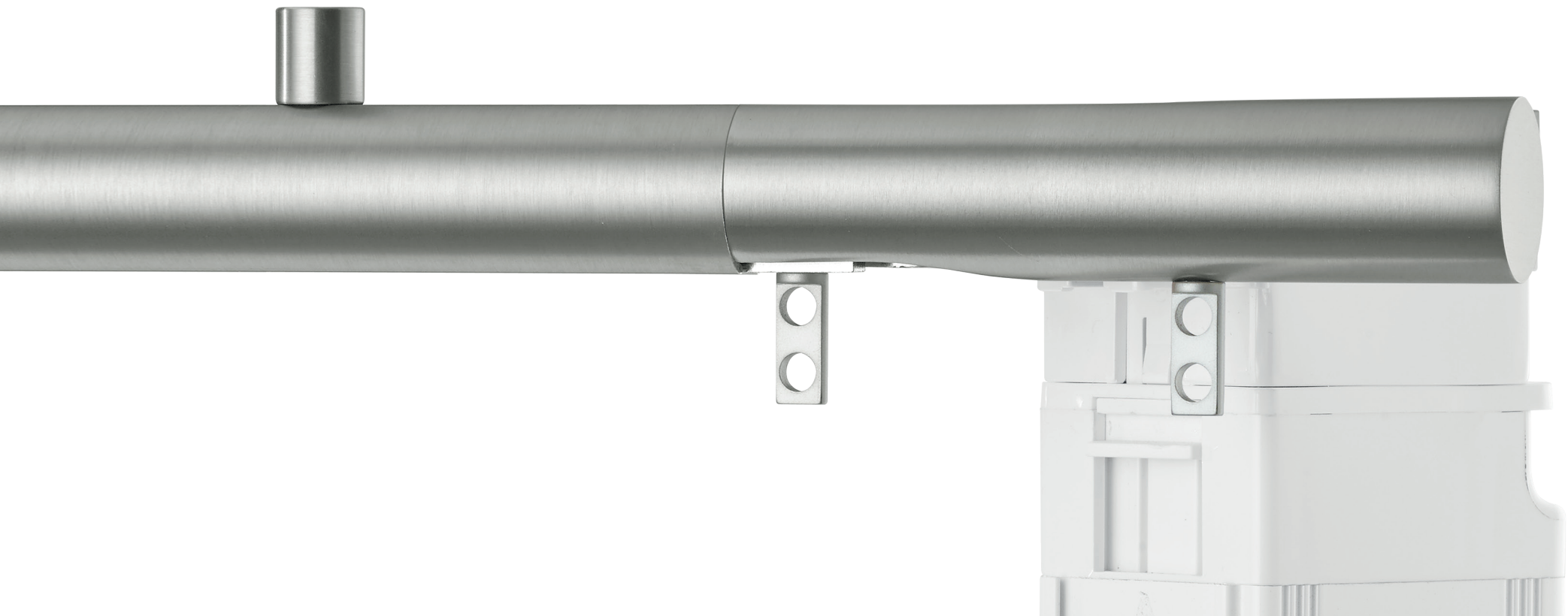

Ø 28 IQ

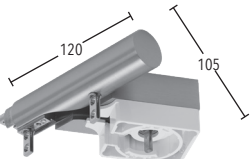

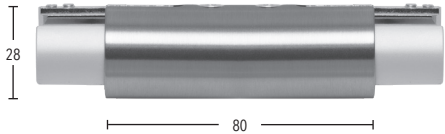
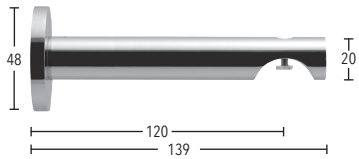
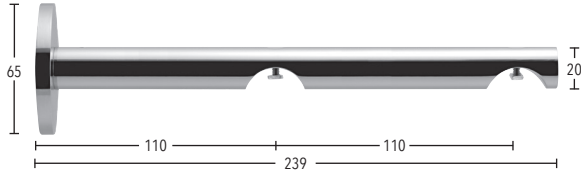
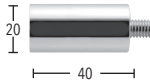
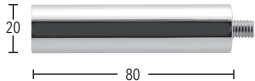
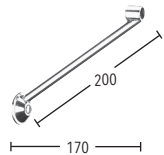

Ø 28 mm IQ Accessories

	ARTICLE	FINISH	ARTICLE-NO.		
	ALUMINIUM-RAIL Ø 28 mm for motorized pole sets Standard length of 6 m	polished chrome satined nickel black matt	809-28-22 -29 -157	Fix length (cut to size)	Standard length
	PULLEY HOUSING, LEFT for rail art. no. 809-28 fits for Somfy motor art.-no. 11690-00, 11691-60-00 and 11692-35-00 PU = 1	polished chrome satined nickel black matt	11699-L-22 -29 -157		
	PULLEY HOUSING, RIGHT for rail art. no. 809-28 fits for Somfy motor art.-no. 11690-00, 11691-60-00 and 11692-35-00 PU = 1	polished chrome satined nickel black matt	11699-R-22 -29 -157		
	PULLEY HOUSING, LEFT for rail art. no. 809-28 fits for Forest motor art.-no. 11681-24-00 and 11682-14-00 PU = 1	polished chrome satined nickel black matt	11679-L-22 -29 -157		
	PULLEY HOUSING, RIGHT for rail art. no. 809-28 fits for Forest motor art.-no. 11681-24-00 and 11682-14-00 PU = 1	polished chrome satined nickel black matt	11679-R-22 -29 -157		
	RETURN PULLEY, LEFT for redirection the transport belt for rail art. no. 809-28 PU = 1	polished chrome satined nickel black matt	11683-L-22 -29 -157		
	RETURN PULLEY, RIGHT for redirection the transport belt for rail art. no. 809-28 PU = 1	polished chrome satined nickel black matt	11683-R-22 -29 -157		
	RETURN PULLEY, SHORT VERSION for redirection the transport belt for rail art. no. 809-28 can be used on both sides PU = 1	polished chrome satined nickel black matt	11683-41-22 -29 -157		

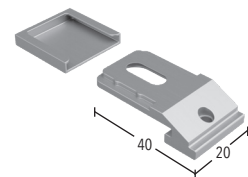
Ø 28 mm IQ Accessories

	ARTICLE	FINISH	ARTICLE-NO.
	DOUBLE-RETURN PULLEY AND CONNECTOR for rail art. no. 809-28 to connect two motorized pole sets, for deflecting the transport belt on both sides PU = 1	polished chrome satined nickel black matt	11683-D-22 -29 -157
	WALL BRACKET (System 4-) single, wall extension 120 mm for rail art. no. 809-28 PU = 2	polished chrome satined nickel black matt	11670-120-22 -29 -157
	WALL BRACKET (System 5-) double, wall extension 110/220 mm with large wall plate for rail art. no. 809-28 PU = 2	polished chrome satined nickel black matt	11672-220-22 -29 -57
	EXTENSION Length 40 mm for wall bracket art. no. 11670 and 11672 PU = 2	polished chrome satined nickel black matt	706-22 -29 -157
	EXTENSION Length 80 mm for wall bracket art. no. 11670 and 11672 PU = 2	polished chrome satined nickel black matt	707-22 -29 -157
	SUPPORTING BRACKET can be cut for wall bracket art. no. 11670 and 11672 PU = 2	polished chrome satined nickel black matt	11950-28.2-22 -29 -57
	CEILING BRACKET 3 mm (System 13-) single, ceiling extension 42 mm for rails PU = 10	silver white black	11592-00 -28 -157
	CEILING BRACKET 3 mm (System 19-) including borehole cover single, ceiling ext. 29 mm for rails PU = 10	silver white black	11597-00 -28 -157

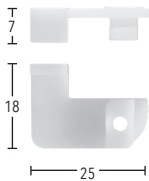

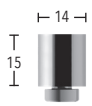
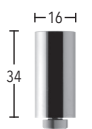
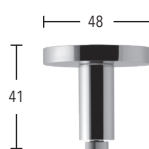
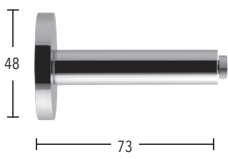
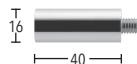
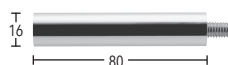

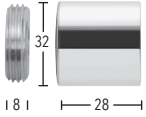
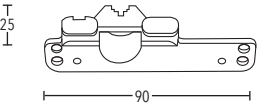

Ø 28 mm IQ Accessories

	ARTICLE	FINISH	ARTICLE-NO.
 <p>Technical drawing of a clamping ceiling bracket. Dimensions: height 18 mm, width 25 mm, and a small offset of 7 mm.</p>	CLAMPING CEILING BRACKET 3 mm single, ceiling extension 28 mm Material: plastic for rails PU = 10	white	11590-10-00
 <p>Technical drawing of a ceiling bracket. Dimensions: height 34 mm, width 40 mm, and a small offset of 6 mm.</p>	CEILING BRACKET 6 mm (System 14-) single, ceiling extension 32 mm for rails PU = 2	polished chrome satined nickel black matt	11590-1-22 -29 -157
 <p>Technical drawing of a ceiling bracket. Dimensions: height 15 mm and width 14 mm.</p>	CEILING BRACKET 15 mm (System 15-) single, ceiling extension 41 mm for rails PU = 10	polished chrome satined nickel black matt	11873-15-22 -29 -157
 <p>Technical drawing of a ceiling bracket. Dimensions: height 34 mm and width 16 mm.</p>	CEILING BRACKET 34 mm (System 16-) single, ceiling extension 60 mm for rails PU = 10	polished chrome satined nickel black matt	11873-30-22 -29 -157
 <p>Technical drawing of a ceiling bracket. Dimensions: height 41 mm and width 48 mm.</p>	CEILING BRACKET 41 single, ceiling extension 67 mm for rails PU = 6	polished chrome satined nickel black matt	11873-50-22 -29 -157
 <p>Technical drawing of a ceiling bracket. Dimensions: height 48 mm and length 73 mm.</p>	CEILING BRACKET 73 single, ceiling extension 99 mm for rails PU = 6	polished chrome satined nickel black matt	11873-80-22 -29 -157
 <p>Technical drawing of an extension. Dimensions: height 16 mm and length 40 mm.</p>	EXTENSION Length 40 mm for ceiling bracket art. no. 11873-50 and 11873-80 PU = 2	polished chrome satined nickel black matt	11870-40-22 -29 -157
 <p>Technical drawing of an extension. Dimensions: height 16 mm and length 80 mm.</p>	EXTENSION Length 80 mm for ceiling bracket art. no. 11873-50 and 11873-80 PU = 2	polished chrome satined nickel black matt	11870-80-22 -29 -157

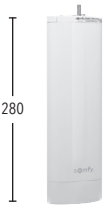

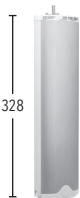
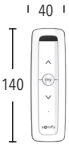

Ø 28 mm IQ Accessories

	ARTICLE	FINISH	ARTICLE-NO.
	RECESS BRACKET for Ø 28 mm PU = 10	polished chrome satined nickel black matt	122028-22 -29 -157
	TRANSPORT BELT Roll 100 meters	green	8809-10-00 Fix length (cut to size)
	TRANSPORT BELT-CONNECTOR PU = 1	white	8809-16-00
	GLIDER PU = 100	white grey black	8809-52-00 -08 -57
	CURTAIN HOOK CURTAIN DOUBLE HOOK PU = 100	white white	869-00 853-00
	MASTER CARRIER, UNDERLAP PU = 1	white grey black	8809-23-00 -08 -57
	MASTER CARRIER, OVERLAP PU = 1	white grey black	8809-24-00 -08 -57
	WAVE CARRIER PU = 1	white grey black	8809-34-00 -08 -57

Ø 28 mm IQ Accessories

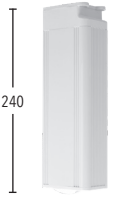
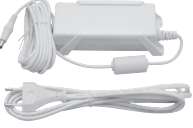
	ARTICLE	FINISH	ARTICLE-NO.
 <p>280</p>	SOMFY DRIVE MOTOR (Battery) MoveLite 35 WireFree RTS incl. battery and USB-charging cable PU = 1 ATTENTION: Please note the different purchasing conditions	white	11692-35-00
	TRANSFORMATOR for USB-Cable for Somfy drive motor MoveLite35 art. no. 11692-35-00 PU = 1 ATTENTION: Please note the different purchasing conditions	black	11692-6-57
 <p>210</p> <p>100</p>	SOMFY DRIVE MOTOR (Battery) Irismo 45 WireFree RTS incl. battery PU = 1 ATTENTION: Please note the different purchasing conditions	white	11690-00
	CHARGING CABLE WITH POWER SUPPLY UNIT for drive motor Somfy Irismo art. no. 11690-00 PU = 1 ATTENTION: Please note the different purchasing conditions	white	11690-6-00
 <p>328</p>	SOMFY DRIVE MOTOR Glydea Ultra 60e RTS Power supply 100 V - 240 V PU = 1 ATTENTION: Please note the different purchasing conditions	white	11691-60-00
 <p>40</p> <p>140</p>	SOMFY REMOTE CONTROL, 5-CHANNEL for all Somfy drive motors PU = 1 ATTENTION: Please note the different purchasing conditions	white	11690-5-00
 <p>318</p>	FOREST SHUTTLE iOn-MOTOR (Battery) incl. battery PU = 1 ATTENTION: Please note the different purchasing conditions	white black	11682-14-00 -57
	CHARGING CABLE WITH POWER SUPPLY UNIT for drive motor Shuttle iOn art. no. 11682-14-00 PU = 1 ATTENTION: Please note the different purchasing conditions	black	11682-15-57

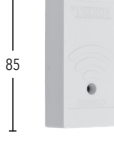
Ø 28 mm IQ Accessories

	ARTICLE	FINISH	ARTICLE-NO.
 <p>240</p>	FOREST SHUTTLE DRIVE MOTOR PU = 1 ATTENTION: Please note the different purchasing conditions	white grey black	11681-24-00 -08 -57
	TRANSFORMATOR 24 V -SHUTTLE with connection cable and holder - EUROPA for drive motor 24 V art. no. 11681-24-00 PU = 1 ATTENTION: Please note the different purchasing conditions	white	11681-3-00
 <p>140</p>	FOREST REMOTE CONTROL, 6-CHANNEL for all Shuttle drive motors PU = 1 ATTENTION: Please note the different purchasing conditions	white black	11681-8-00 -57
 <p>85</p>	FOREST WIFI DONGLE for drive motor Shuttle 24V art. no. 11681-14 enables control via the Forest Connect app PU = 1 ATTENTION: Please note the different purchasing conditions	white black	11680-10-00 -57
	FOREST WLAN POWER SOCKET incl. connector and accessories for Shuttle iOn drive motor art. no. 11682-15 and Shuttle 24V art. no. 11681-14 enables control via the Forest Connect app PU = 1 ATTENTION: Please note the different purchasing conditions	white	11680-13-00

Ø 28 mm IQ Illustrations

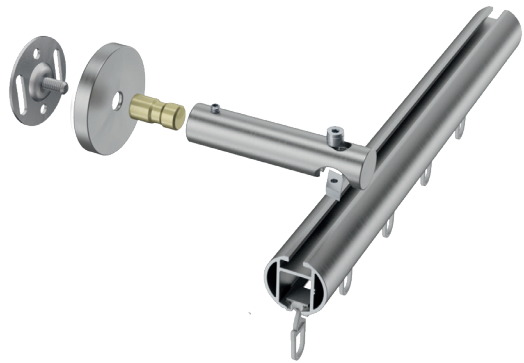

Wall bracket
art. no. 11670-120

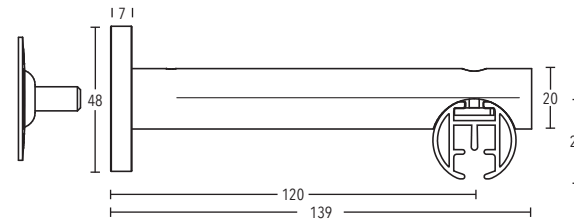

Wall bracket
art. no. 11672-220

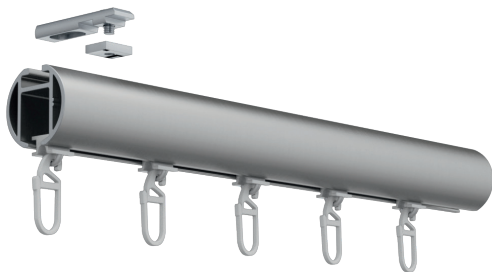
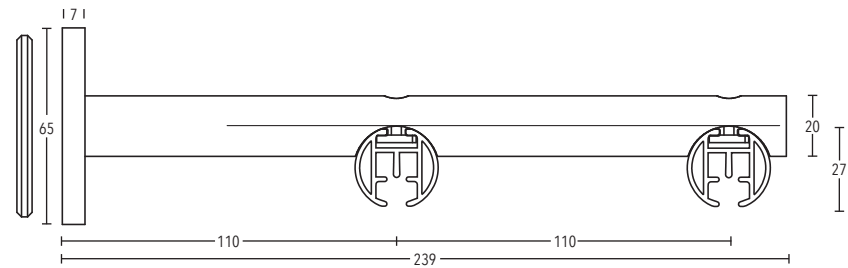

Ceiling bracket 3 mm
art. no. 11592

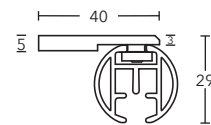

Ceiling bracket 3 mm
art. no. 11597

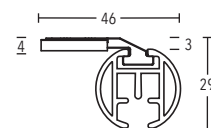

Ø 28 mm IQ Illustrations

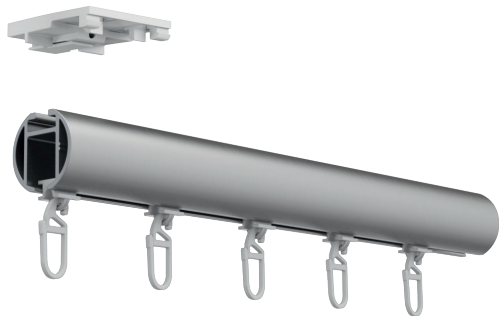

Snap-In ceiling bracket 6 mm
art. no. 11693-00

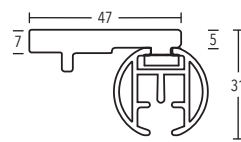

Ceiling bracket 6 mm
art. no. 11590-1

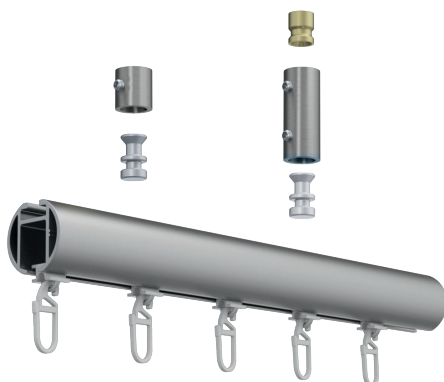
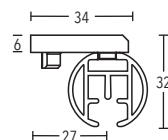

Ceiling bracket 15 mm + 34 mm
art. no. 11873-15 + 11873-30

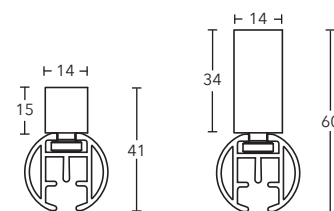

Ceiling bracket 41 mm + 73 mm
art. no. 11873-50 + 11873-80

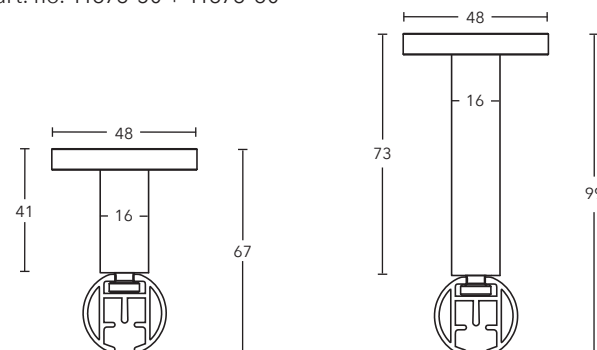

Ø 28 mm IQ Illustrations

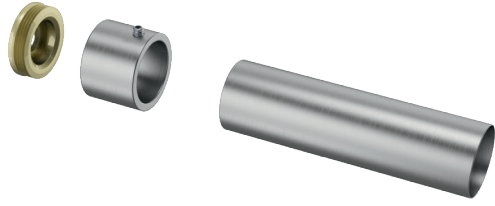

Recess bracket
art. no. 122028

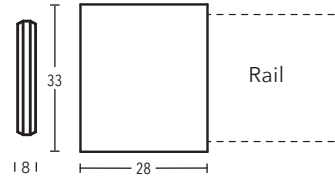

BÜSCHE

TECDOR IQ-Series

Ø 40 IQ - Motorized Pole Sets

Ø 40 mm

satined nickel

Pole set no. 4-40212-29

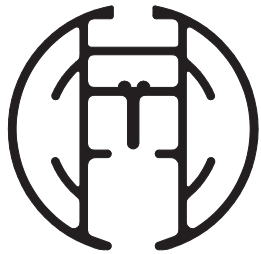

Finishes:



-28 white



-29 satined nickel



-157 black matt





somfy IRISMO WIREFREE 45 RTS EU WRAT
74300-France

somfy

somfy

Ø 40 IQ

Ø 40 mm IQ

WALL- AND CEILING INSTALLATION / Ø 40 mm / SINGLE/DOUBLE RAIL

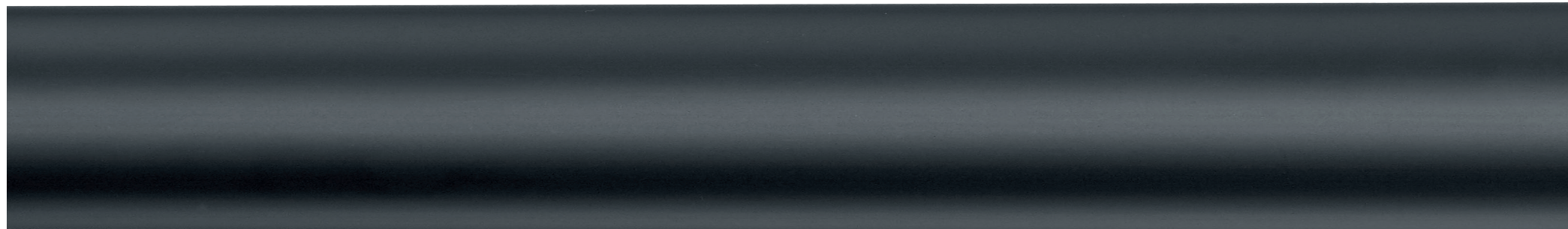

Ø 40 mm IQ - black matt - Page 122 - Pole set no. 4-40212-157

AVAILABLE FINISHES



-28 white



-29 satined nickel



-157 black matt

Illustrations on a scale of 1 : 1



Ø 40 IQ



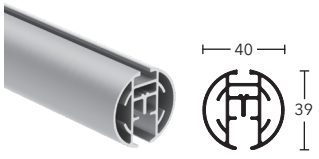
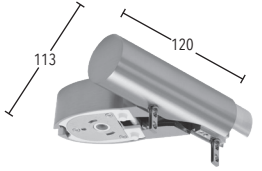
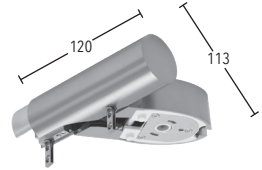
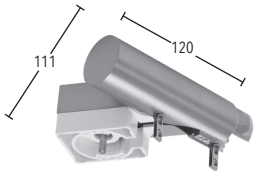
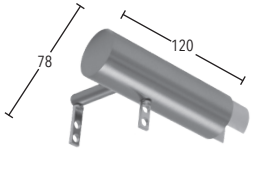
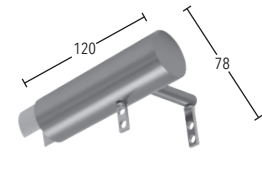
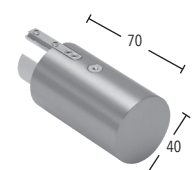

Ø 40 mm IQ Accessories

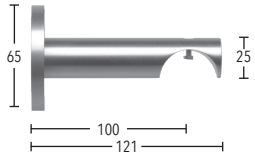
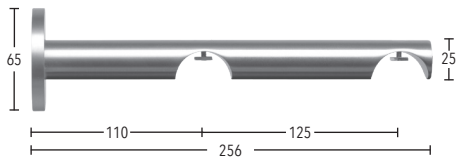
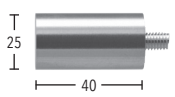
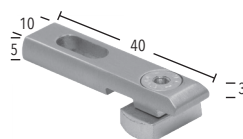
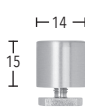
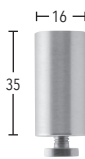
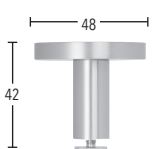
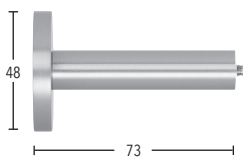
	ARTICLE	FINISH	ARTICLE-NO.		
	ALUMINIUM RAIL Ø 40 mm for motorized pole sets Standard length of 6 m	white satined nickel black matt	809-40-28 -29 -157	Fix length (cut to size)	Standard length
	PULLEY HOUSING, LEFT for rail art.-no. 809-40 fits for Somfy motor art.-no. 11690-00, 11691-60-00 and 11692-35-00 PU = 1	white satined nickel black matt	11699-L-40-28 -29 -157		
	PULLEY HOUSING, RIGHT for rail art.-no. 809-40 fits for Somfy motor art.-no. 11690-00, 11691-60-00 and 11692-35-00 PU = 1	white satined nickel black matt	11699-R-40-28 -29 -157		
	PULLEY HOUSING, LEFT for rail art.-no. 809-40 fits for Forest motor art.-no. 11681-24-00 and 11682-14-00 PU = 1	white satined nickel black matt	11679-L-40-28 -29 -157		
	PULLEY HOUSING, RIGHT for rail art.-no. 809-40 fits for Forest motor art.-no. 11681-24-00 and 11682-14-00 PU = 1	white satined nickel black matt	11679-R-40-28 -29 -157		
	RETURN PULLEY, LEFT for rail art.-no. 809-40 for redirection the transport belt PU = 1	white satined nickel black matt	11683-L-40-28 -29 -157		
	RETURN PULLEY, RIGHT for rail art.-no. 809-40 for redirection the transport belt PU = 1	white satined nickel black matt	11683-R-40-28 -29 -157		
	RETURN PULLEY, SHORT VERSION for rail art.-no. 809-40 for redirection the transport belt usable on both sides PU = 1	white satined nickel black matt	11686-40-28 -29 -157		



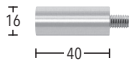
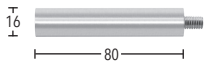
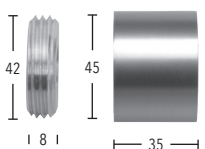

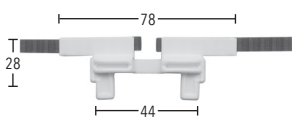

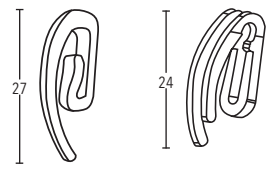
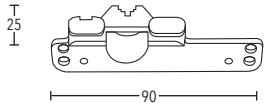
Ø 40 mm IQ Accessories

	ARTICLE	FINISH	ARTICLE-NO.
	WALL BRACKET (System 4-) single, extension 100 mm with large wall plate 65 mm for rail art.-no. 809-40 PU = 6	white satined nickel black matt	40870-28 -29 -157
	WALL BRACKET (System 5-) double, extension 110/235 mm with large wall plate 65 mm for rail art.-no. 809-40 PU = 6	white satined nickel black matt	40872-235-28 -29 -157
	EXTENSION length 40 mm for wall bracket art.-no. 4087x PU = 2	white satined nickel black matt	806-28 -29 -157
	CEILING BRACKET 3 mm (System 13-) Single, ceiling extension 42 mm for rails PU = 10	silver white black	11592-00 -28 -157
	CEILING BRACKET 15 mm (System 15-) single, ceiling extension 54 mm for rails PU = 10	white satined nickel black matt	11873-15-28 -29 -157
	CEILING BRACKET 35 mm (System 16-) single, ceiling extension 73 mm for rails PU = 10	white satined nickel black matt	11873-30-28 -29 -157
	CEILING BRACKET 42 mm (System 17-) single, ceiling extension 80 mm for rails PU = 10	white satined nickel black matt	11873-50-28 -29 -157
	CEILING BRACKET 80 mm single, ceiling extension 119 mm for rails PU = 10	white satined nickel black matt	11873-80-28 -29 -157

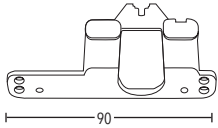

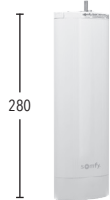

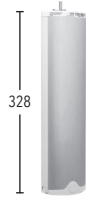
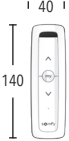

Ø 40 mm IQ Accessories

	ARTICLE	FINISH	ARTICLE-NO.
	EXTENSION length 40 mm for wall bracket art.-no. 11873-50 and 11873-80 PU = 2	white satined nickel black matt	11870-40-28 -29 -157
	EXTENSION length 80 mm for wall bracket art.-no. 11873-50 and 11873-80 PU = 2	white satined nickel black matt	11870-80-28 -29 -157
	RECESS BRACKET for Ø 40 mm PU = 10	white satined nickel black matt	122040-28 -29 -157
	TRANSPORT BELT Roll 100 meters Price € per metre	green	8809-10-00 Fix length (cut to size)
	TRANSPORT BELT-CONNECTOR PU = 1	white gray black	8809-11-00 -08 -57
	GLIDER PU = 100	white gray black	8809-52-00 -08 -57
	CURTAIN HOOK CURTAIN DOUBLE HOOK PU = 100	white white	869-00 853-00
	MASTER CARRIER, UNDERLAP PU = 1	white gray black	8809-23-00 -08 -57

Ø 40 mm IQ Accessories

	ARTICLE	FINISH	ARTICLE-NO.
	MASTER CARRIER, OVERLAP PU = 1	white gray black	8809-24-00 -08 -57
	WAVE CARRIER PU = 1	white gray black	8809-34-00 -08 -57
	SOMFY DRIVE MOTOR (Battery) MoveLite 35 WireFree RTS incl. battery and USB-charging cable PU = 1 ATTENTION: Please note the different purchasing conditions	white	11692-35-00
	TRANSFORMATOR for USB-Cable for Somfy drive motor MoveLite35 art. no. 11692-35-00 PU = 1 ATTENTION: Please note the different purchasing conditions	black	11692-6-57
	SOMFY DRIVE MOTOR (Battery) Irismo 45 WireFree RTS incl. battery PU = 1 ATTENTION: Please note the different purchasing conditions	white	11690-00
	CHARGING CABLE WITH POWER SUPPLY UNIT for drive motor Somfy Irismo art. no. 11690-00 PU = 1 ATTENTION: Please note the different purchasing conditions	white	11690-6-00
	SOMFY DRIVE MOTOR Glydea Ultra 60e RTS Power supply 100 V - 240 V PU = 1 ATTENTION: Please note the different purchasing conditions	white	11691-60-00
	SOMFY REMOTE CONTROL, 5-CHANNEL for all Somfy drive motors PU = 1 ATTENTION: Please note the different purchasing conditions	white	11690-5-00

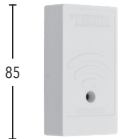
Ø 40 mm IQ Accessories

	ARTICLE	FINISH	ARTICLE-NO.
	FOREST SHUTTLE iOn-MOTOR (Battery) incl. battery PU = 1 ATTENTION: Please note the different purchasing conditions	white black	11682-14-00 -57
	CHARGING CABLE WITH POWER SUPPLY UNIT for drive motor Shuttle iOn art. no. 11682-14-00 PU = 1 ATTENTION: Please note the different purchasing conditions	black	11682-15-57
	FOREST SHUTTLE DRIVE MOTOR PU = 1 ATTENTION: Please note the different purchasing conditions	white gray black	11681-24-00 -08 -57
	TRANSFORMATOR 24 V -SHUTTLE with connection cable and holder - EUROPA for drive motor 24 V art. no. 11681-24-00 PU = 1 ATTENTION: Please note the different purchasing conditions	white	11681-3-00
	FOREST REMOTE CONTROL, 6-CHANNEL for all Shuttle drive motors PU = 1 ATTENTION: Please note the different purchasing conditions	white black	11681-8-00 -57
	FOREST WIFI DONGLE for drive motor Shuttle 24V art. no. 11681-14 enables control via the Forest Connect app PU = 1 ATTENTION: Please note the different purchasing conditions	white black	11680-10-00 -57
	FOREST WLAN POWER SOCKET incl. connector and accessories for Shuttle iOn drive motor art. no. 11682-15 and Suttle 24V art. no. 11681-14 enables control via the Forest Connect app PU = 1 ATTENTION: Please note the different purchasing conditions	white	11680-13-00

Ø 40 mm IQ Illustrations

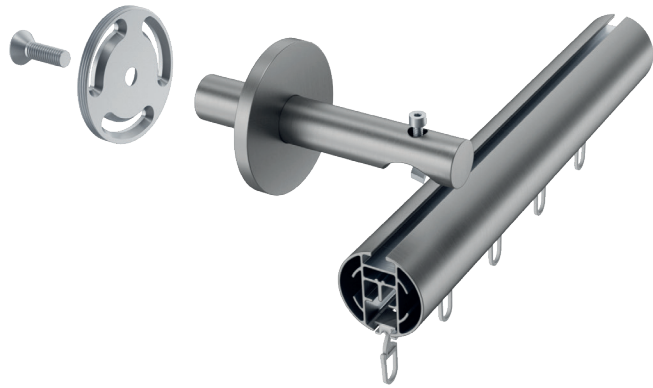

Wall bracket
art. no. 40870

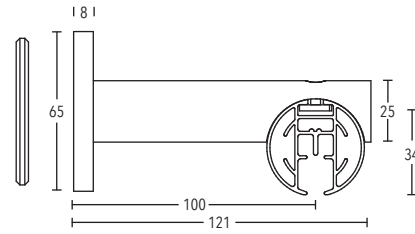

Wall bracket
art. no. 40872-235

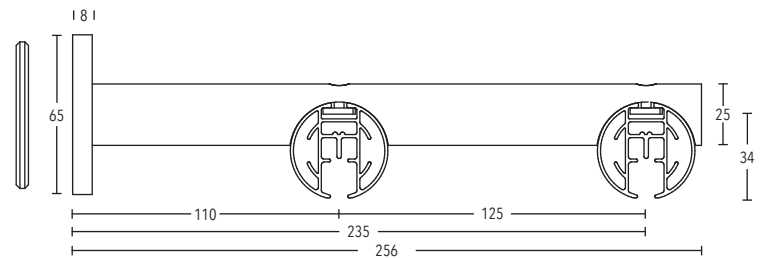

Ceiling bracket 3 mm
art. no. 11592

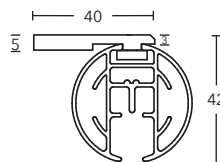

Ø 40 mm IQ Illustrations

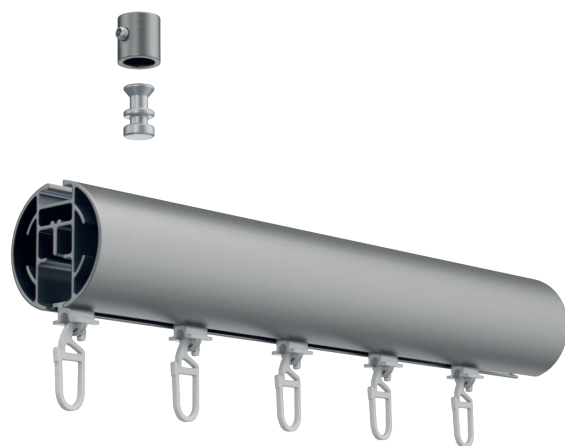

Ceiling bracket 15 mm
art. no. 11873-15

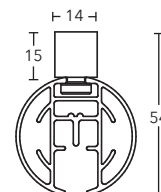

Ceiling bracket 34 mm
art. no. 11873-30

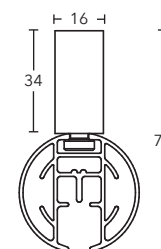

Ceiling bracket 41 mm + 80 mm
art. no. 11873-50 + 11873-80

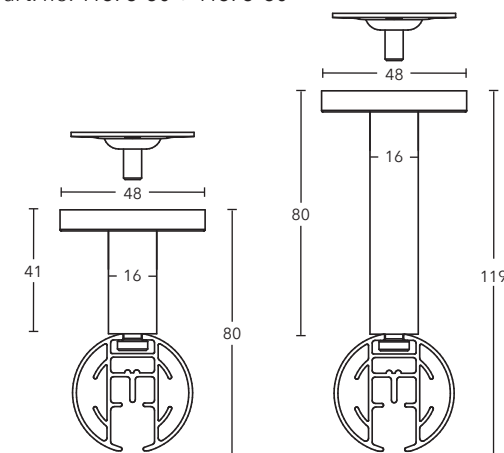

Ø 40 mm IQ Illustrations

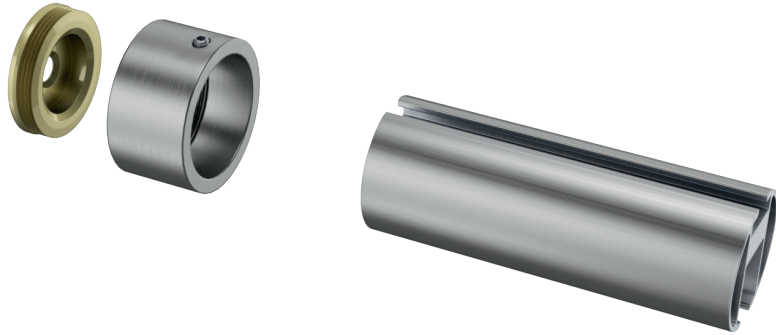

Recess bracket
art. no. 122040

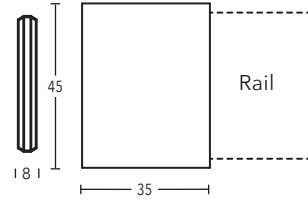

BÜSCHE

TECDOR IQ-Series

Pur IQC - Corded pole sets

32 x 46 mm

black matt

Pole set no. 12-32469-157



Finishes:



-08 sat. aluminium



-22 polished chrome



-29 sat. nickel



-48 white matt



-157 black matt



-209 brushed gold



-850 brushed palladium

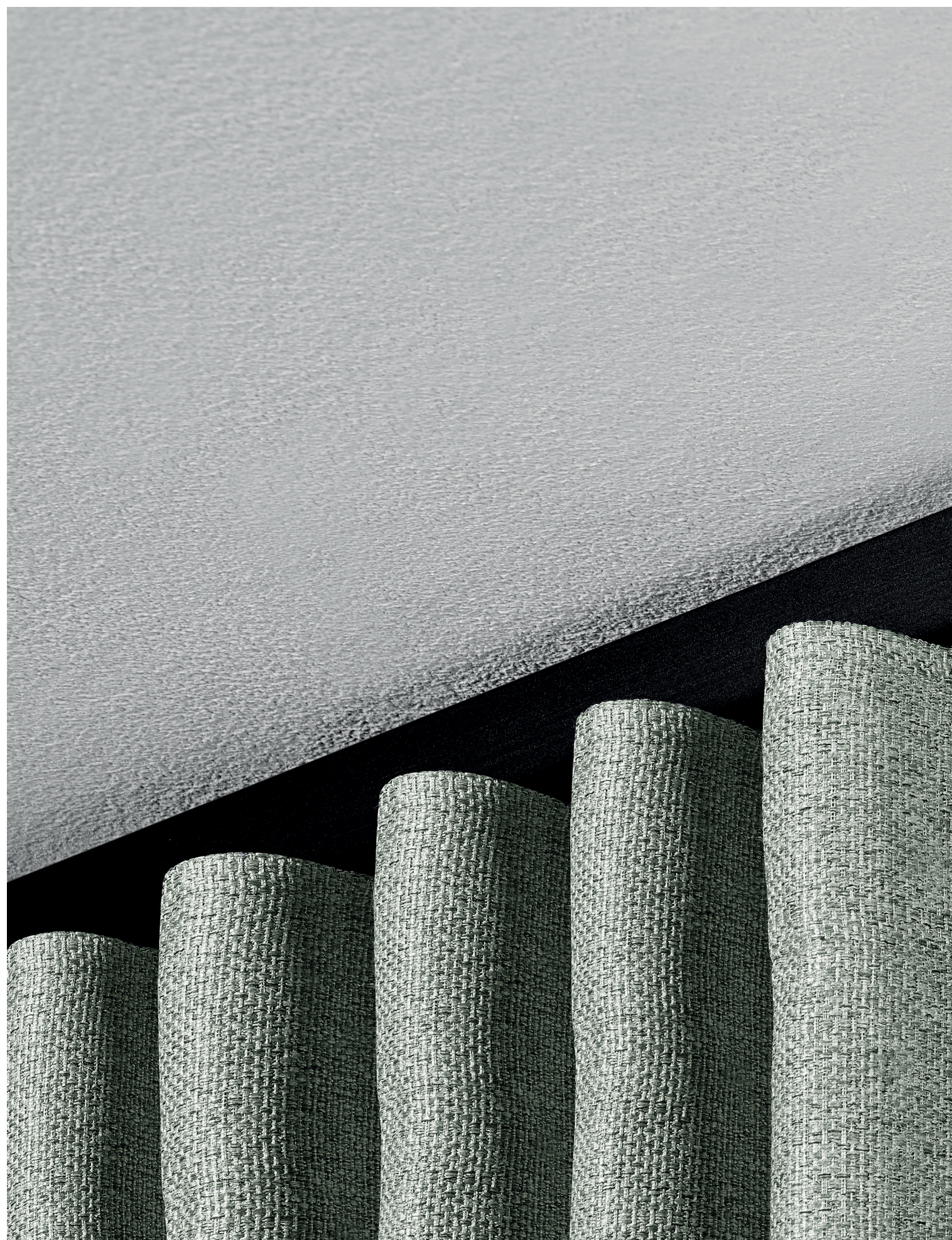



**GERMAN
DESIGN
AWARD
SPECIAL
2022**

Pur IQC 32 x 46 mm

WALL- AND CEILING INSTALLATION / 32 X 46 mm / SINGLE RAIL



PUR IQC - black matt - Page 140 - Pole set no. 12-32469-157

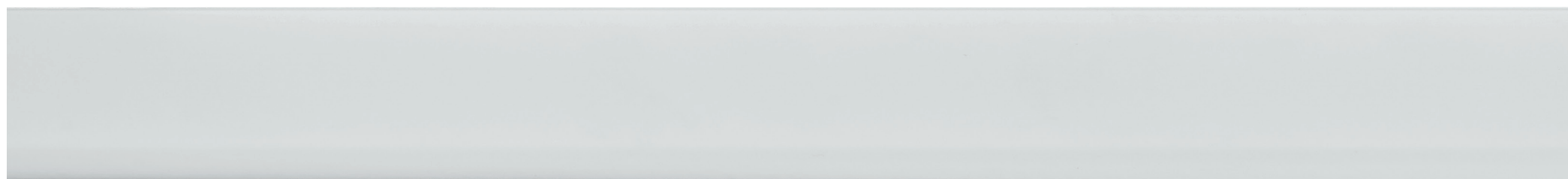

PUR IQC - white matt - Page 140 - Pole set no. 0-32469-48



FINISHES AVAILABLE



-08 sat. aluminium



-22 polished chrome

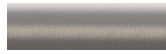

-29 sat. nickel



-48 white matt



-157 black matt



-209 brushed gold



-850 brushed palladium



Illustrations on a scale of 1 : 1



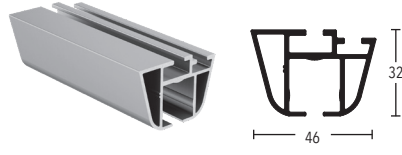
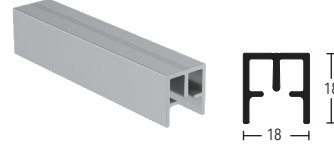
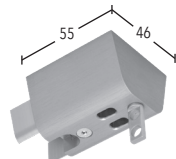
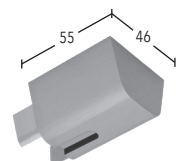
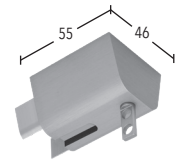
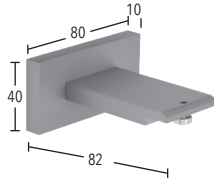
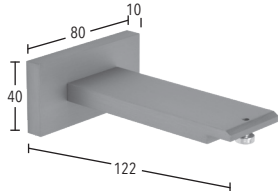
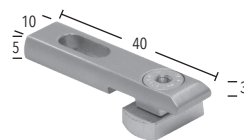

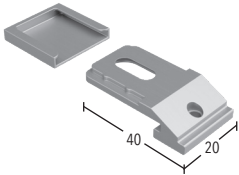
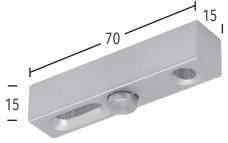
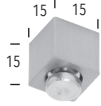
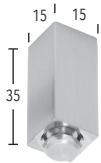
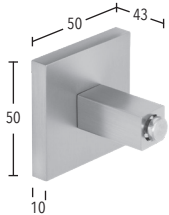
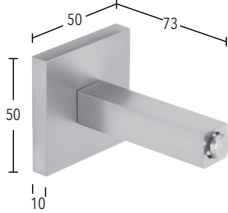
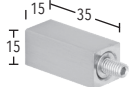

Pur IQC 32 x 46 mm Accessories

	ARTICLE	FINISH	ARTICLE-NO.		
	ALUMINIUM-RAIL PUR 32 x 46 mm Standard length 6 m	sat. aluminium polished chrome sat. nickel white matt black matt brushed gold brushed palladium	8223246-08 -22 -29 -48 -157 -209 -850	Fix length (cut to size)	Standard length
	ALUMINIUM-INSERT-RAIL required for corded pole sets Standard length 6 m	silver black	8221818-108 -157	Fix length (cut to size)	Standard length
	PULLEY HOUSING WITH EYELET for rail art. no. 8223246 PU = 1	sat. aluminium polished chrome sat. nickel white matt black matt brushed gold brushed palladium	11687-46-08 -22 -29 -48 -157 -209 -850		
	RETURN PULLEY PUR for redirection the transport cord for rail art. no. 8223246 PU = 1	sat. aluminium polished chrome sat. nickel white matt black matt brushed gold brushed palladium	11686-46-08 -22 -29 -48 -157 -209 -850		
	RETURN PULLEY PUR WITH EYELET for redirection the transport cord for rail art. no. 8223246 PU = 1	sat. aluminium polished chrome sat. nickel white matt black matt brushed gold brushed palladium	11686-46-E-08 -22 -29 -48 -157 -209 -850		
	WALL BRACKET (System 0-) single, wall extension 90 mm for rail art. no. 8223246 PU = 6	sat. aluminium polished chrome sat. nickel white matt black matt brushed gold brushed palladium	11260-90-08 -22 -29 -48 -157 -209 -850		
	WALL BRACKET (System 1-) single, wall extension 130 mm for rail art. no. 8223246 PU = 6	sat. aluminium polished chrome sat. nickel white matt black matt brushed gold brushed palladium	11260-130-08 -22 -29 -48 -157 -209 -850		
	CEILING BRACKET 3 mm (System 13-) single, ceiling extension 32 mm for rails PU = 10	silver white black	11592-00 -28 -157		

Pur IQC 32 x 46 mm Accessories

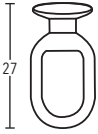
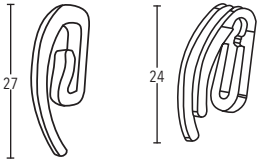
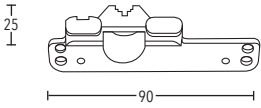
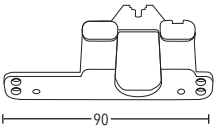
	ARTICLE	FINISH	ARTICLE-NO.
	CEILING BRACKET 3 mm (System 11-) including drill hole cover single, ceiling extension 32 mm for rails PU = 10	silver white black	11597-00 -28 -157
	CEILING BRACKET 15 mm (System 12-) single, ceiling extension 47 mm for rails PU = 10	sat. aluminium polished chrome sat. nickel white matt black matt brushed gold brushed palladium	11473-100-08 -22 -29 -48 -157 -209 -850
	CEILING BRACKET 15 mm (System 15-) single, ceiling extension 47 mm for rails PU = 10	sat. aluminium polished chrome sat. nickel white matt black matt brushed gold brushed palladium	11473-15-08 -22 -29 -48 -157 -209 -850
	CEILING BRACKET 35 mm (System 16-) single, ceiling extension 67 mm for rails PU = 10	sat. aluminium polished chrome sat. nickel white matt black matt brushed gold brushed palladium	11473-35-08 -22 -29 -48 -157 -209 -850
	CEILING BRACKET 43 mm (System 17-) single, ceiling extension 75 mm for rails PU = 6	sat. aluminium polished chrome sat. nickel white matt black matt brushed gold brushed palladium	11473-50-08 -22 -29 -48 -157 -209 -850
	CEILING BRACKET 73 mm single, ceiling extension 105 mm for rails PU = 6	sat. aluminium polished chrome sat. nickel white matt black matt brushed gold brushed palladium	11473-80-08 -22 -29 -48 -157 -209 -850
	EXTENSION (SQUARE) length 35 mm for all ceiling brackets art. no. 11473-35, 11473-50 and 11473-80 PU = 2	sat. aluminium polished chrome sat. nickel white matt black matt brushed gold brushed palladium	11473-2/2-08 -22 -29 -48 -157 -209 -850
	TRANSPORT CORD Role 250 metre	white grey black	8809-20-00 -08 -57

Pur IQC 32 x 46 mm Accessories

	ARTICLE	FINISH	ARTICLE-NO.
	TRANSPORT CORD CONNECTOR PU = 1	white grey black	8809-41-00 -08 -57
	GLIDER PU = 100	white grey black	8809-52-00 -08 -57
	CURTAIN HOOK CURTAIN DOUBLE HOOK PU = 100	white white	869-00 853-00
	MASTER CARRIER, UNDERLAP PU = 1	white grey black	8809-23-00 -08 -57
	MASTER CARRIER, OVERLAP PU = 1	white grey black	8809-24-00 -08 -57
	WAVE CARRIER PU = 1	white grey black	8809-34-00 -08 -57
	CORD WEIGHT CYLINDER weight approx. 140 g PU = 1	sat. aluminium polished chrome sat. nickel white matt black matt gold matt brushed palladium	11688-08 -22 -29 -48 -157 -209 -850
	CORD WEIGHT CYLINDER with rubber ring weight approx. 150 g PU = 1	sat. aluminium polished chrome sat. nickel white matt black matt gold matt brushed palladium	11689-08 -22 -29 -48 -157 -209 -850

Pur IQC 32 x 46 mm Illustrations



Wall bracket
art. no. 11260-90

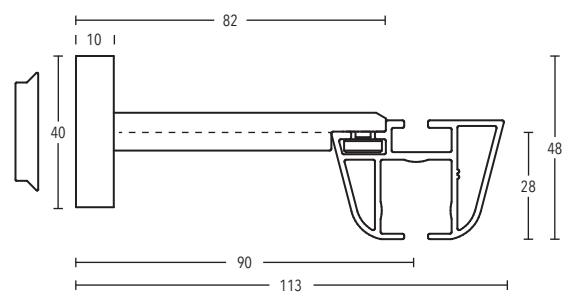

Wall bracket
art. no. 11260-130

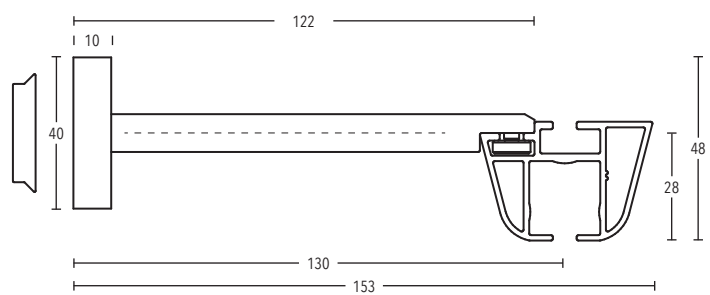

Ceiling bracket 3 mm
art. no. 11592

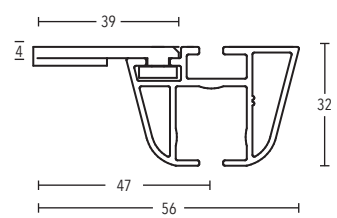

Pur IQC 32 x 46 mm Illustrations



Ceiling bracket 3 mm
art. no. 11597

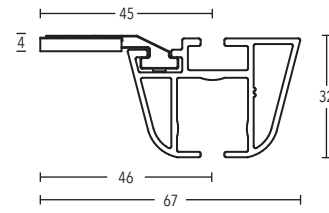

Ceiling bracket 15 mm
art. no. 11473-100

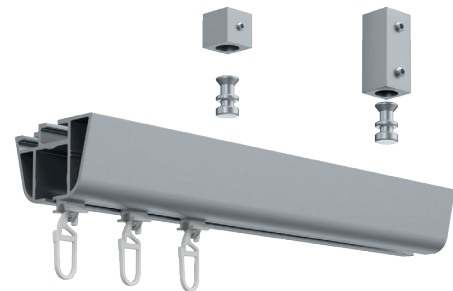
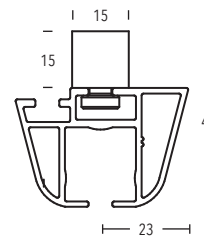

Ceiling bracket 15 mm + 35 mm
art. no. 11473-15 + 11473-35

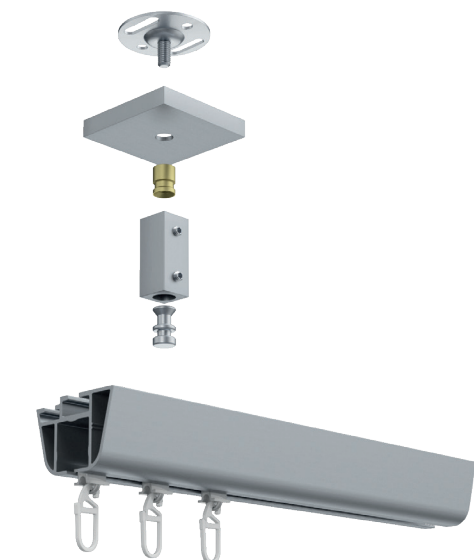
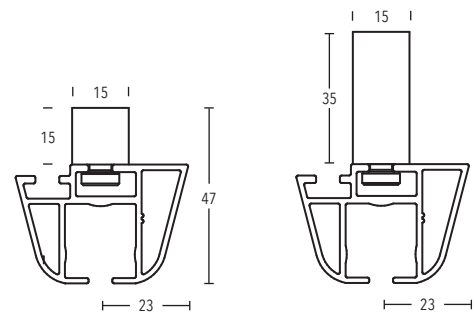

Ceiling bracket 43 mm + 73 mm
art. no. 11473-50 + 11473-80

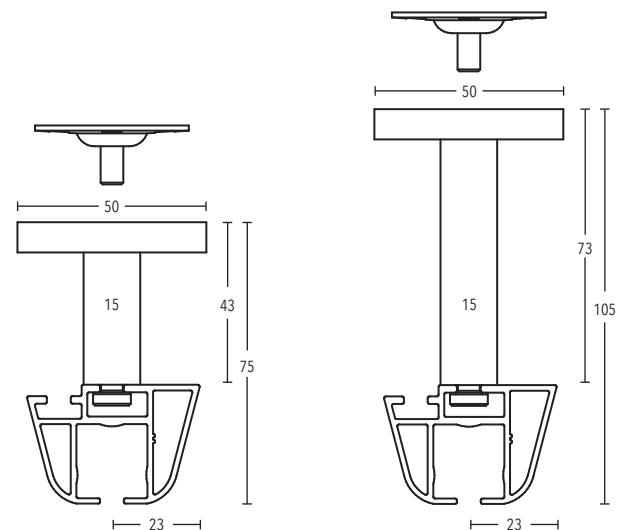

BÜSCHE

TECDOR IQ-Series

Cos IQC - Corded pole sets

32 x 53 mm

sat. nickel

Pole set no. 1-32539-29

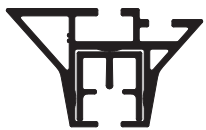

Finishes:



-29 sat. nickel



-48 white matt



-157 black matt





Cos IQC 32 x 53 mm

WALL- AND CEILING INSTALLATION / 32 X 53 mm / SINGLE RAIL



COS IQC - sat. nickel - Page 152 - Pole set no. 0-32539-29



COS IQC - black matt - Page 152 - Pole set no. 0-32539-157



FINISHES AVAILABLE

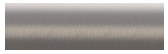

-29 sat. nickel



-48 white matt



-157 black matt



Illustrations on a scale of 1 : 1



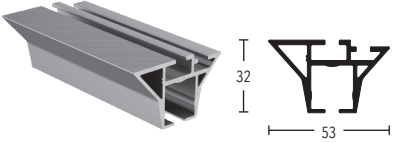
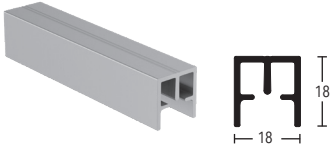
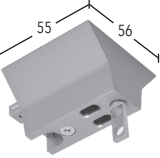
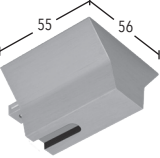
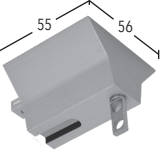
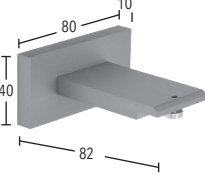
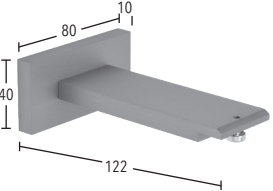
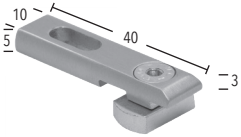



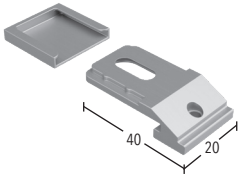
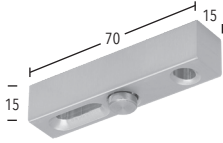
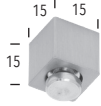
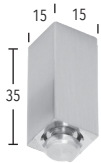
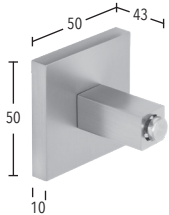
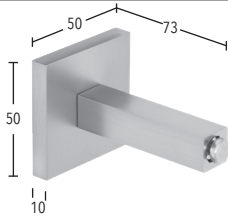
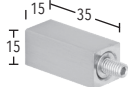

Cos IQC 32 x 53 mm Accessories

	ARTICLE	FINISH	ARTICLE-NO.		
	ALUMINIUM-RAIL COS 32 x 53 mm Standard length 6 m	sat. nickel white matt black matt	8223253-29 -48 -157	Fix length (cut to size)	Standard length
	ALUMINIUM-INSERT-RAIL required for corded pole sets Standard length 6 m Note: mandatory for each system	silver black	8221818-108 -157	Fix length (cut to size)	Standard length
	PULLEY HOUSING COS WITH EYELET for rail art. no. 8223253 PU = 1	sat. nickel white matt black matt	11687-53-29 -48 -157		
	RETURN PULLEY COS for redirection the transport cord for rail art. no. 8223253 PU = 1	sat. nickel white matt black matt	11686-53-29 -48 -157		
	RETURN PULLEY COS WITH EYELET for redirection the transport cord for rail art. no. 8223253 PU = 1	sat. nickel white matt black matt	11686-53-E-29 -48 -157		
	WALL BRACKET (System 0-) single, wall extension 90 mm for rail art. no. 8223253 PU = 6	sat. nickel white matt black matt	11260-90-29 -48 -157		
	WALL BRACKET (System 1-) single, wall extension 130 mm for rail art. no. 8223253 PU = 6	sat. nickel white matt black matt	11260-130-29 -48 -157		
	CEILING BRACKET 3 mm (System 13-) single, ceiling extension 32 mm for rails PU = 10	silver white black	11592-00 -28 -157		

Cos IQC 32 x 53 mm Accessories

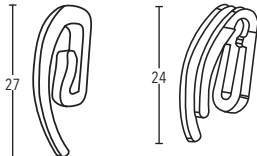
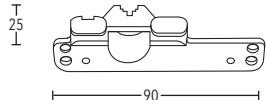
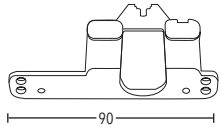
	ARTICLE	FINISH	ARTICLE-NO.
	CEILING BRACKET 3 mm (System 11-) including drill hole cover single, ceiling extension 32 mm for rails PU = 10	silver white black	11597-00 -28 -157
	CEILING BRACKET 15 mm (System 12-) single, ceiling extension 47 mm for rails PU = 10	sat. nickel white matt black matt	11473-100-29 -48 -157
	CEILING BRACKET 15 mm (System 15-) single, ceiling extension 47 mm for rails PU = 10	sat. nickel white matt black matt	11473-15-29 -48 -157
	CEILING BRACKET 35 mm (System 16-) single, ceiling extension 67 mm for rails PU = 10	sat. nickel white matt black matt	11473-35-29 -48 -157
	CEILING BRACKET 43 mm (System 17-) single, ceiling extension 75 mm for rails PU = 6	sat. nickel white matt black matt	11473-50-29 -48 -157
	CEILING BRACKET 73 mm single, ceiling extension 105 mm for rails PU = 6	sat. nickel white matt black matt	11473-80-29 -48 -157
	EXTENSION (SQUARE) length 35 mm for all ceiling brackets art. no. 11473-35, 11473-50 and 11473-80 PU = 2	sat. nickel white matt black matt	11473-2/2-29 -48 -157
	TRANSPORT CORD Role 250 metre Price € per metre	white grey black	8809-20-00 -08 -57

Cos IQC 32 x 53 mm Accessories

	ARTICLE	FINISH	ARTICLE-NO.
	TRANSPORT CORD CONNECTOR PU = 1	white grey black	8809-41-00 -08 -57
	GLIDER PU = 100	white grey black	8809-52-00 -08 -57
	CURTAIN HOOK CURTAIN DOUBLE HOOK PU = 100	white white	869-00 853-00
	MASTER CARRIER, UNDERLAP PU = 1	white grey black	8809-23-00 -08 -57
	MASTER CARRIER, OVERLAP PU = 1	white grey black	8809-24-00 -08 -57
	WAVE CARRIER PU = 1	white grey black	8809-34-00 -08 -57
	CORD WEIGHT CYLINDER weight approx. 140 g PU = 1	sat. nickel white matt black matt	11688-29 -48 -157
	CORD WEIGHT CYLINDER with rubber ring weight approx. 150 g PU = 1	sat. nickel white matt black matt	11689-29 -48 -157

Cos IQC 32 x 53 mm Illustrations

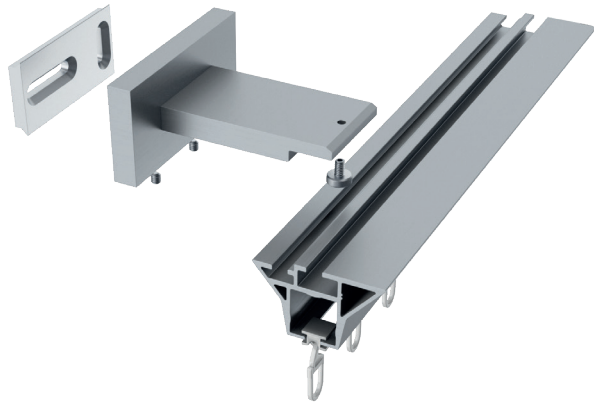

Wall bracket
art. no. 11260-90

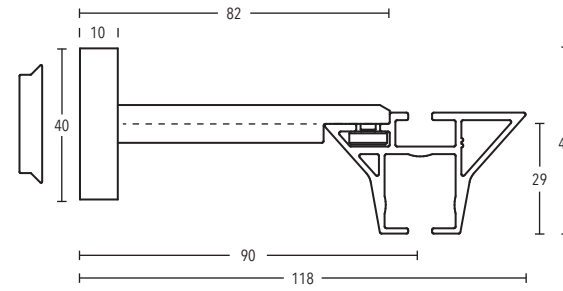

Wall bracket
art. no. 11260-130

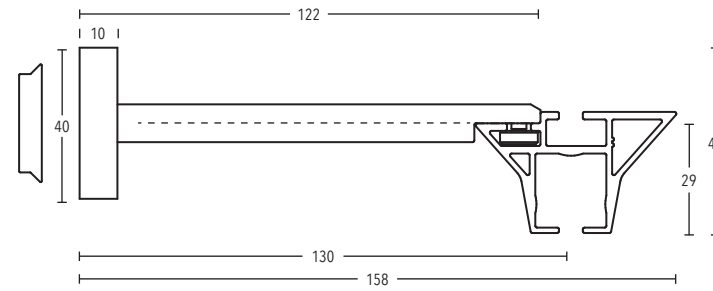

Ceiling bracket 3 mm
art. no. 11592-00

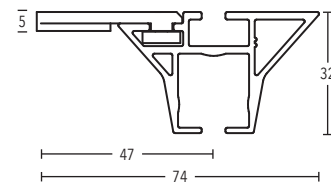

Ceiling bracket 3 mm
art. no. 11597-00

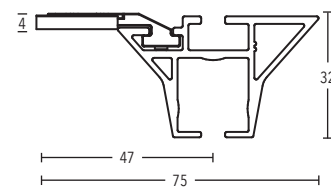

Cos IQC 32 x 53 mm Illustrations



Ceiling bracket 15 mm
art. no. 11473-100

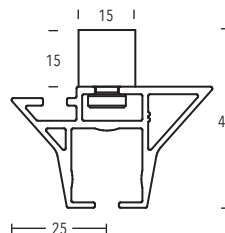

Ceiling bracket 15 mm + 35 mm
art. no. 11473-15 + 11473-35

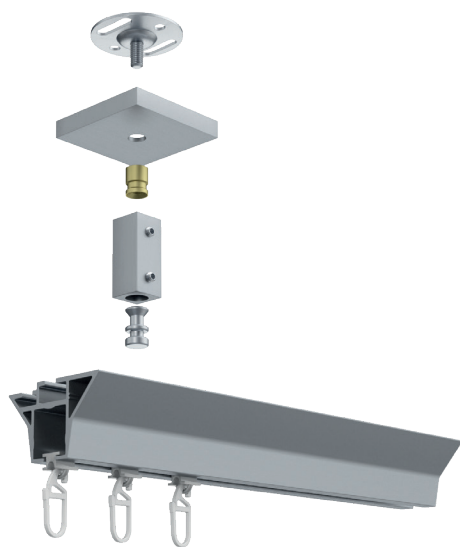
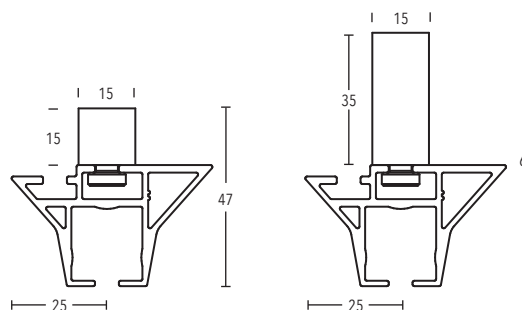

Ceiling bracket 43 mm + 73 mm
art. no. 11473-50 + 11473-80

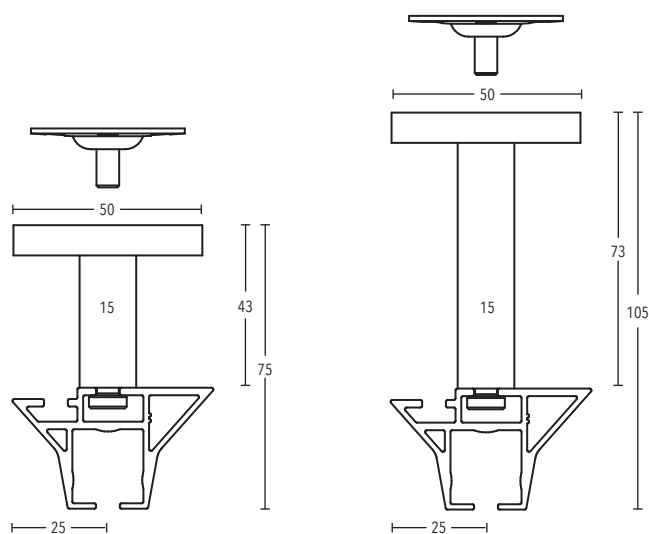

BÜSCHE

TECDOR IQ-Series

Lep IQC - Corded pole sets

31 x 90 mm

brushed palladium

Pole set no. 1-31909-850



Finishes:

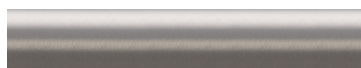

-29 sat. nickel



-157 black matt



-209 brushed gold



-850 brushed palladium





Lep IQC 31 x 90 mm

WALL- AND CEILING INSTALLATION / 31 X 90 mm / SINGLE RAIL



LEP IQC - brushed gold - Page 164 - Pole set no. 1-31909-209



LEP IQC - brushed palladium - Page 164 - Pole set no. 1-31909-850



FINISHES AVAILABLE

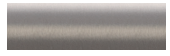

-29 sat. nickel



-157 black matt



-209 brushed gold



-850 brushed palladium

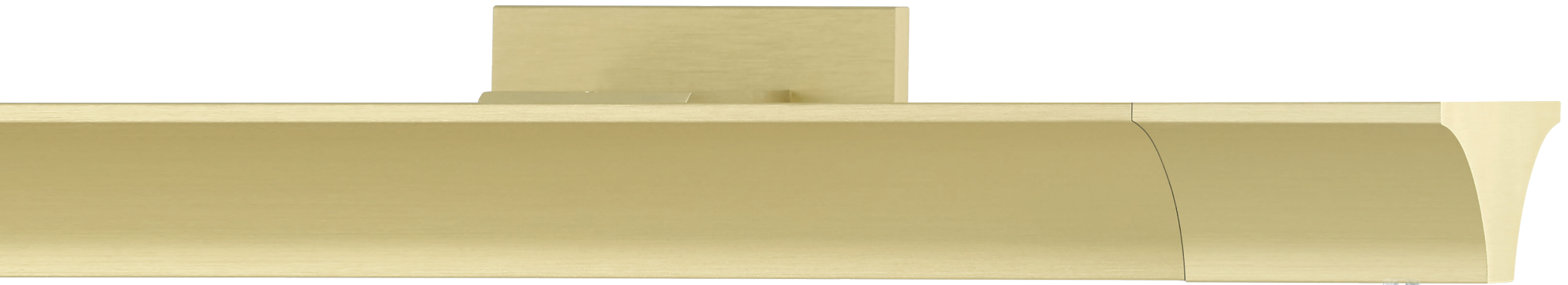

Illustrations on a scale of 1 : 1



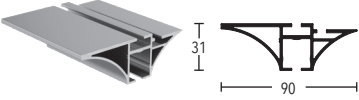
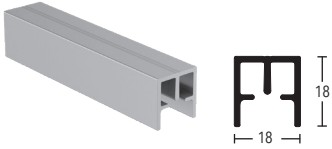
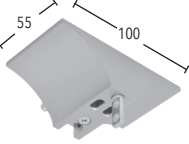
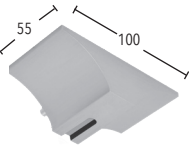
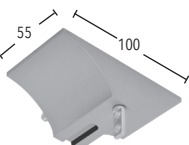
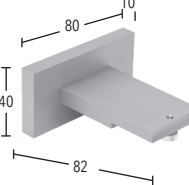
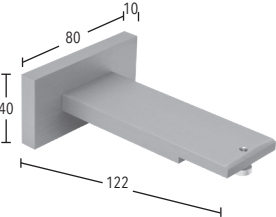
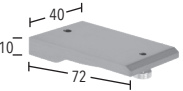

Lep IQC 31 x 90 mm Accessories

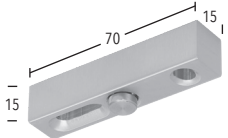
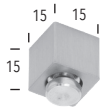
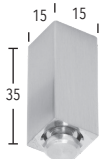
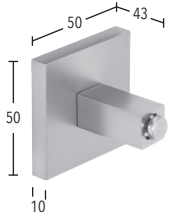
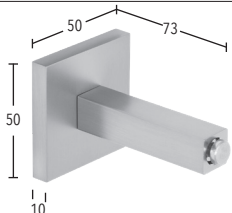
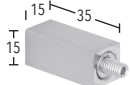
	ARTICLE	FINISH	ARTICLE-NO.		
	ALUMINIUM-RAIL LEP 31 x 90 mm Price € per metre Standard length 6 m	sat. nickel black matt brushed gold brushed palladium	8223190-29 -157 -209 -850	Fix length (cut to size)	Standard length
	ALUMINIUM-INSERT-RAIL required for corded pole sets Price € per metre Standard length 6 m Note: mandatory for each system	silver black	8221818-108 -157	Fix length (cut to size)	Standard length
	PULLEY HOUSING LEP WITH EYELET for rail art. no. 8223190 PU = 1	sat. nickel black matt brushed gold brushed palladium	11687-90-29 -157 -209 -850		
	RETURN PULLEY LEP for redirection the transport cord for rail art. no. 8223190 PU = 1	sat. nickel black matt brushed gold brushed palladium	11686-90-29 -157 -209 -850		
	RETURN PULLEY LEP WITH EYELET for redirection the transport cord for rail art. no. 8223190 PU = 1	sat. nickel black matt brushed gold brushed palladium	11686-90-E-29 -157 -209 -850		
	WALL BRACKET LEP (System 0-) single, wall extension 90 mm for rail art. no. 8223190 PU = 6	sat. nickel black matt brushed gold brushed palladium	11220-90-29 -157 -209 -850		
	WALL BRACKET LEP (System 1-) single, wall extension 130 mm for rail art. no. 8223190 PU = 6	sat. nickel black matt brushed gold brushed palladium	11220-130-29 -157 -209 -850		
	CEILING BRACKET LEP 5 mm (System 10-) single, ceiling extension 32 mm for rail art. no. 8223190 PU = 10	sat. nickel black matt brushed gold brushed palladium	11220-20-29 -157 -209 -850		

Lep IQC 31 x 90 mm Accessories

	ARTICLE	FINISH	ARTICLE-NO.
	CEILING BRACKET 15 mm (System 12-) single, ceiling extension 46 mm for rails PU = 10	sat. nickel black matt brushed gold brushed palladium	11473-100-29 -157 -209 -850
	CEILING BRACKET 15 mm (System 15-) single, ceiling extension 46 mm for rails PU = 10	sat. nickel black matt brushed gold brushed palladium	11473-15-29 -157 -209 -850
	CEILING BRACKET 35 mm (System 16-) single, ceiling extension 66 mm for rails PU = 10	sat. nickel black matt brushed gold brushed palladium	11473-35-29 -157 -209 -850
	CEILING BRACKET 43 mm (System 17-) single, ceiling extension 74 mm for rails PU = 6	sat. nickel black matt brushed gold brushed palladium	11473-50-29 -157 -209 -850
	CEILING BRACKET 73 mm single, ceiling extension 104 mm for rails PU = 6	sat. nickel black matt brushed gold brushed palladium	11473-80-29 -157 -209 -850
	EXTENSION (SQUARE) length 35 mm for all brackets 11473-35, 11473-50 and 11473-80 PU = 10	sat. nickel black matt brushed gold brushed palladium	11473-2/2-29 -157 -209 -850
	TRANSPORT CORD Role 250 metre	white grey black	8809-20-00 -08 -57
	TRANSPORT CORD CONNECTOR PU = 1	white grey black	8809-41-00 -08 -57

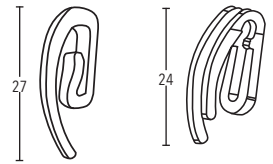
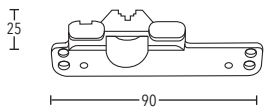
Lep IQC 31 x 90 mm Accessories

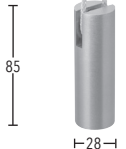
	ARTICLE	FINISH	ARTICLE-NO.
	GLIDER	white	8809-52-00
	PU = 100	grey black	-08 -57
	CURTAIN HOOK	white	869-00
	PU = 100	white	853-00
	MASTER CARRIER, UNDERLAP	white	8809-23-00
	PU = 1	grey black	-08 -57
	MASTER CARRIER, OVERLAP	white	8809-24-00
	PU = 1	grey black	-08 -57
	WAVE CARRIER	white	8809-34-00
	PU = 1	grey black	-08 -57
	CORD WEIGHT CYLINDER	sat. nickel	11688-29
	weight approx. 140 g PU = 1	black matt brushed gold brushed palladium	-157 -209 -850
	CORD WEIGHT CYLINDER	sat. nickel	11689-29
	with rubber ring weight approx. 150 g PU = 1	black matt brushed gold brushed palladium	-157 -209 -850

Lep IQC 31 x 90 mm Illustrations

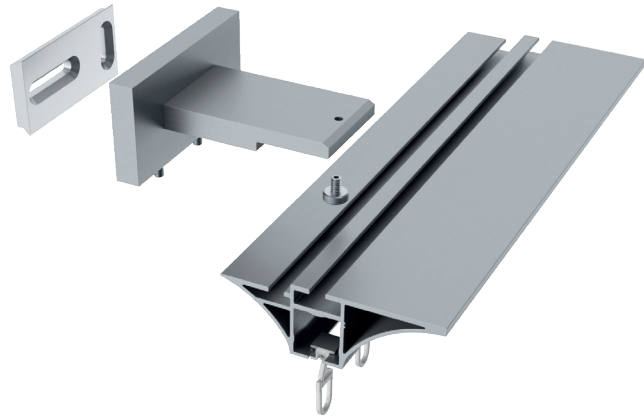

Wall bracket
art. no. 11220-90

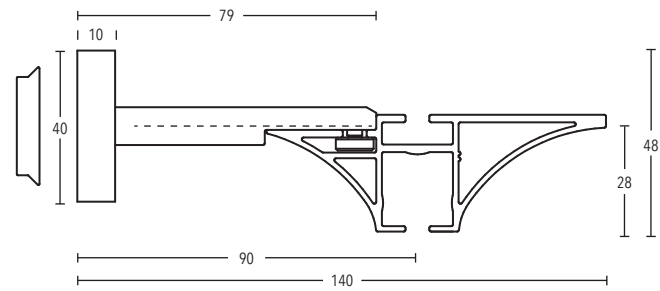

Wall bracket
art. no. 11220-130

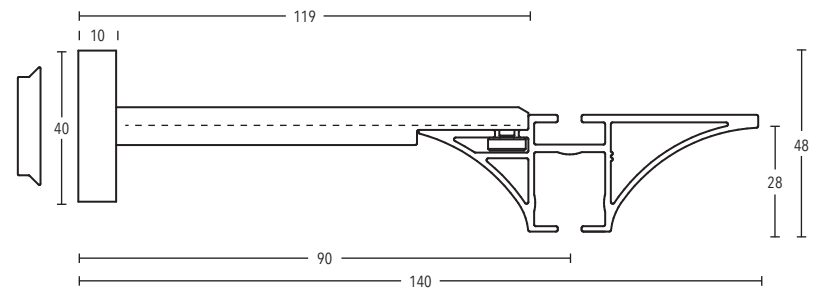

Ceiling bracket 5 mm
art. no. 11220-20

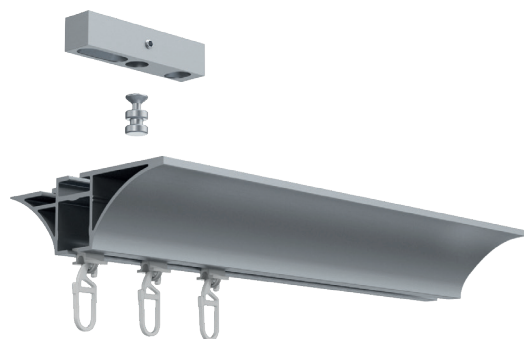
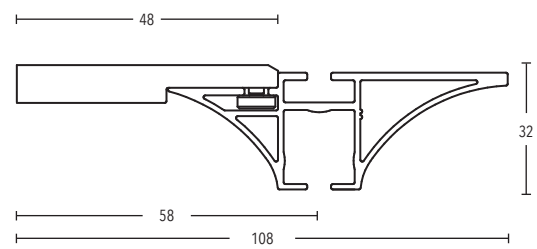

Ceiling bracket 15 mm
art. no. 11473-100

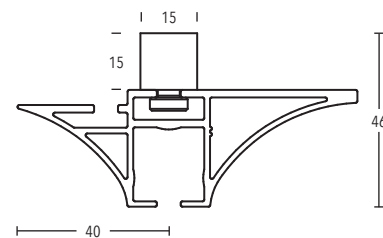

Lep IQC 31 x 90 mm Illustrations



Ceiling bracket 15 mm + 35 mm
art. no. 11473-15 + 11473-35

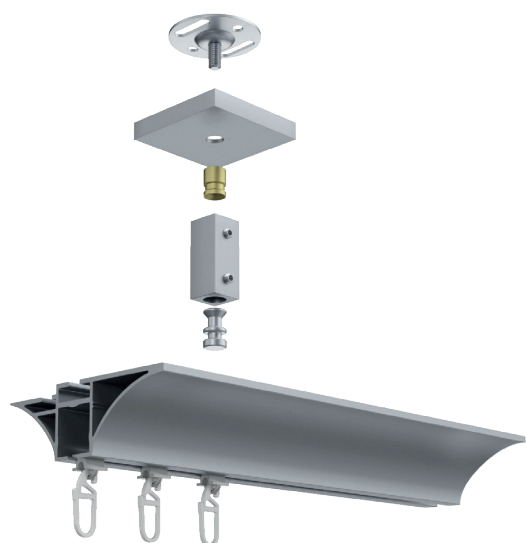
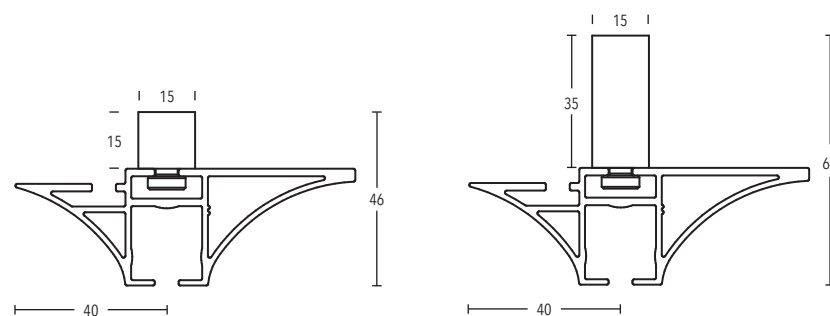

Ceiling bracket 43 mm + 73 mm
art. no. 11473-50 + 11473-80

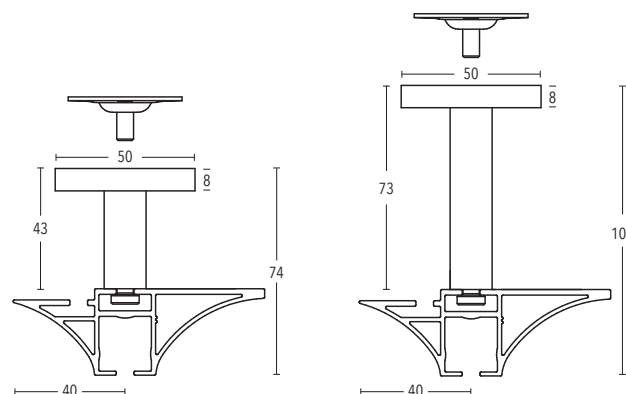

BÜSCHE

TECDOR IQ-Series

40 x 15 mm IQC - Rectangular rail
Corded pole sets

40 x 15 mm

black matt

Pole set no. 15-40715-157



Finishes:



-29 sat. nickel



-157 black matt



-209 brushed gold

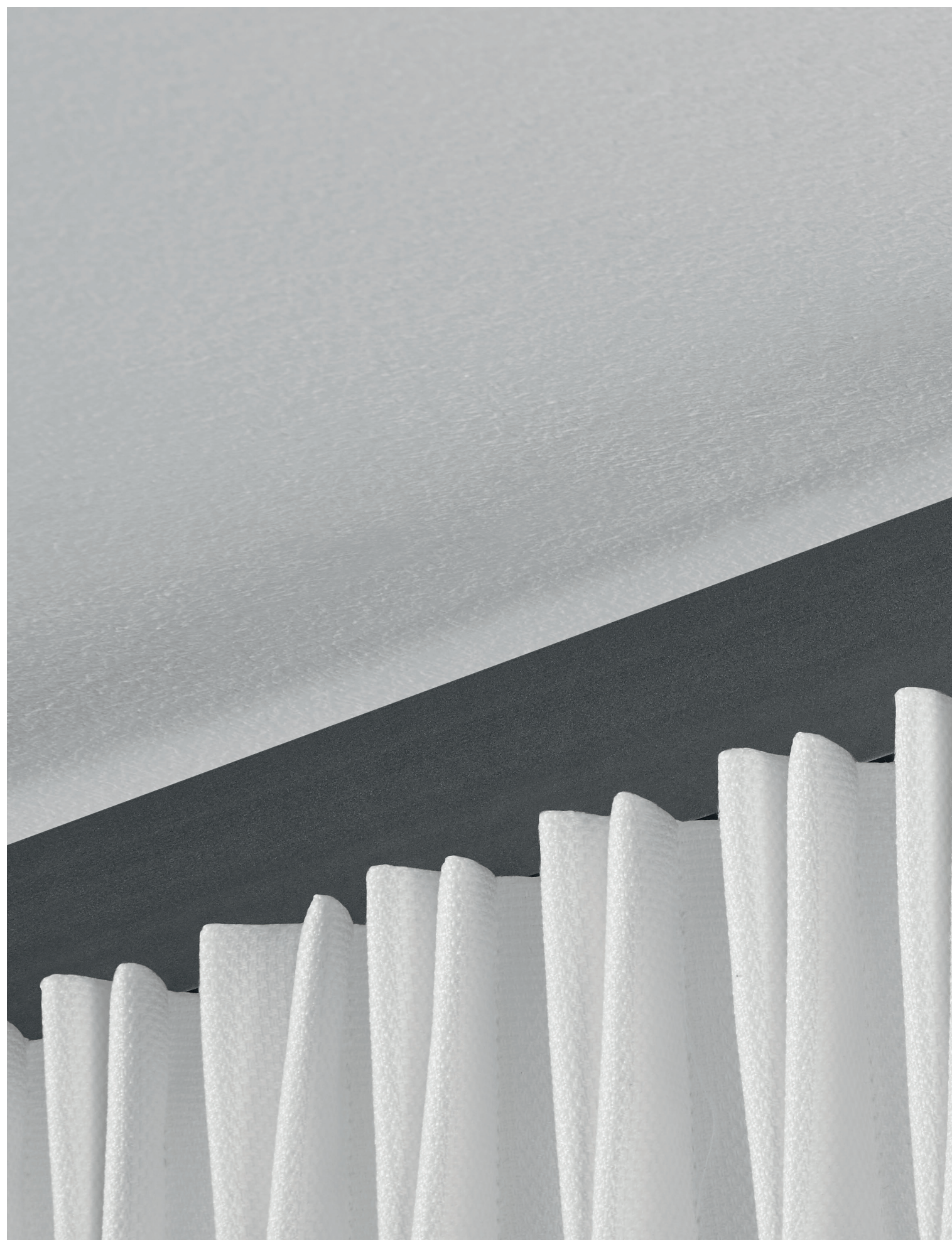



40 x 15 mm IQC

WALL- AND CEILING INSTALLATION / 40 X 15 mm / SINGLE/DOUBLE RAIL



40 x 15 mm IQC - sat. nickel - Page 176 - Pole set no. 1-40715-29



40 x 15 mm IQC - black matt - Page 176 - Pole set no. 12-40715-157

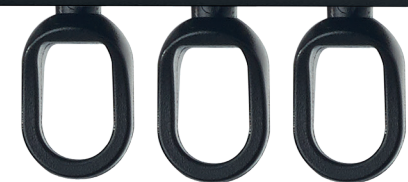

FINISHES AVAILABLE

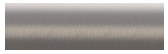

-29 sat. nickel



-157 black matt



-209 brushed gold

Illustrations on a scale of 1 : 1

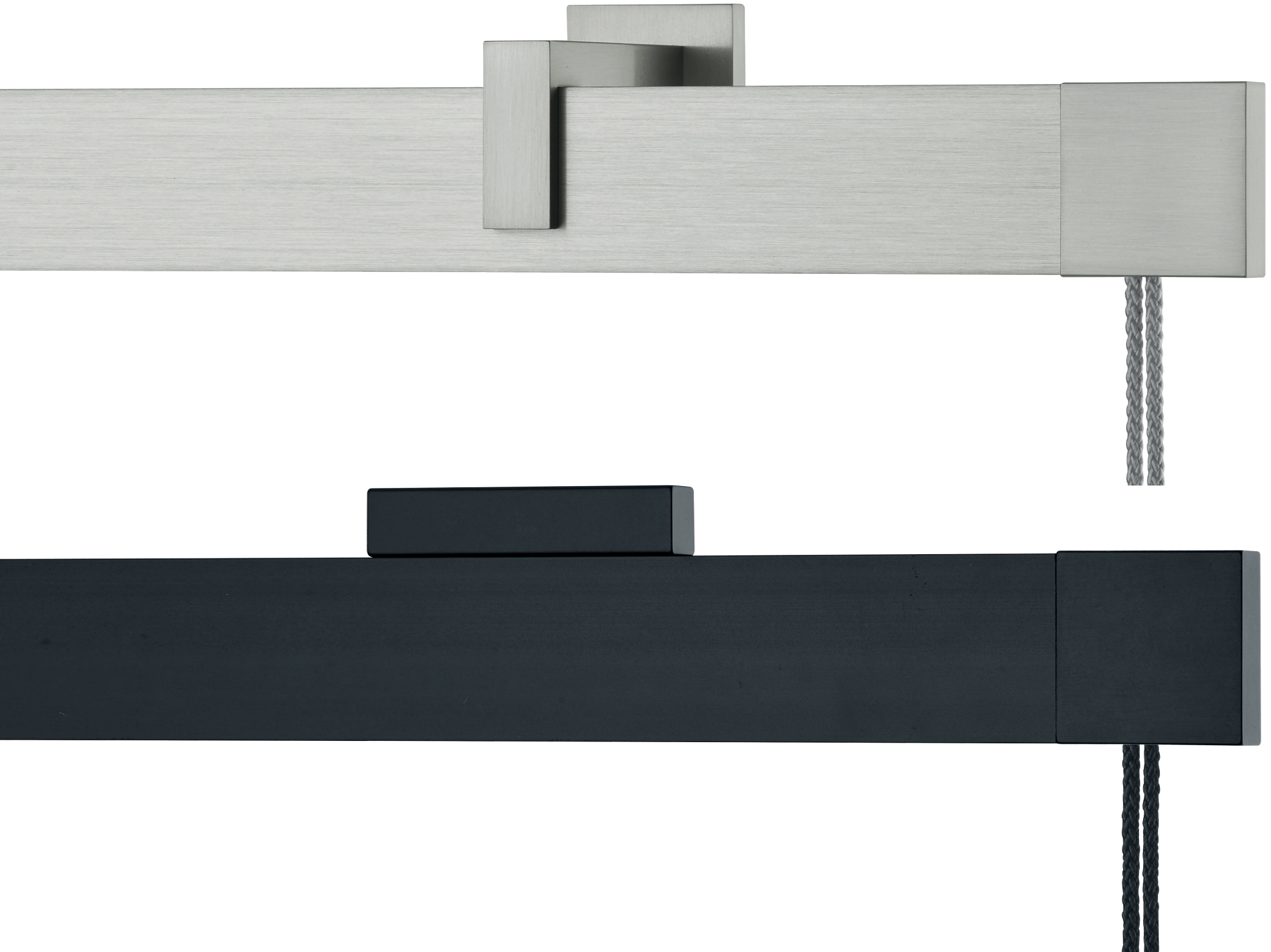



40 x 15 IQC



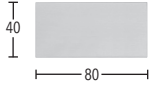
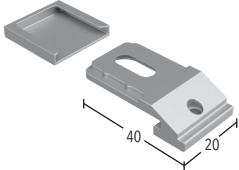
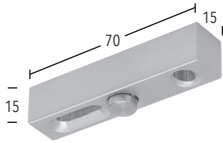
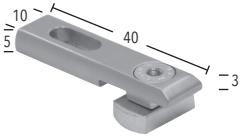
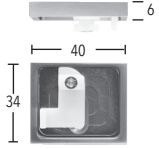

40 x 15 mm IQC Accessories

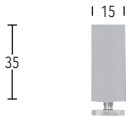
	ARTICLE	FINISH	ARTICLE-NO.	
	RECTANGULAR RAIL 40 X 15 mm for corded pole sets Standard length 6 m	sat. nickel black matt brushed gold	8074015-29 Fix length -157 (cut to size) -209	Standard length
	PULLEY HOUSING PENTA WITH EYELET for rail art. no. 8074015 PU = 1	sat. nickel black matt brushed gold	11452-E-29 -157 -209	
	RETURN PULLEY PENTA for redirection the transport cord for rail art. no. 8074015 PU = 1	sat. nickel black matt brushed gold	11453-29 -157 -209	
	RETURN PULLEY PENTA WITH EYELET for redirection the transport cord for rail art. no. 8074015 PU = 1	sat. nickel black matt brushed gold	11453-E-29 -157 -209	
	WALL BRACKET (System 1-) single, wall extension 80 mm for rail art. no. 8074015 PU = 6	sat. nickel black matt brushed gold	11570-80-29 -157 -209	
	WALL BRACKET (System 2-) double, wall extension 80/140 mm for rail art. no. 8074015 PU = 2	sat. nickel black matt brushed gold	11570-2-29 -157 -209	
	WALL BRACKET double, wall extension 90/190 mm for rail art. no. 8074015 PU = 2	sat. nickel black matt brushed gold	11570-2-190-29 -157 -209	
	EXTENSION length 40 mm for wall bracket art. no. 11570-x PU = 2	sat. nickel black matt brushed gold	11501-40-29 -157 -209	

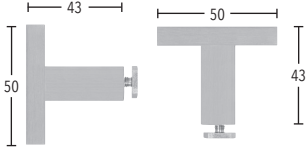
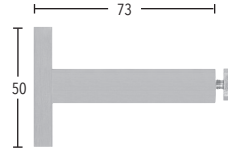
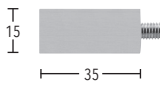

40 x 15 mm IQC Accessories

	ARTICLE	FINISH	ARTICLE-NO.
	EXTENSION length 80 mm for wall bracket art. no. 11570-x PU = 2	sat. nickel black matt brushed gold	11501-80-29 -157 -209
	CEILING BRACKET 3 mm (System 11-) including drill hole cover single, ceiling extension 43 mm for rails PU = 10	silver white black	11597-00 -28 -157
	CEILING BRACKET 15 mm (System 12-) single, ceiling extension 55 mm for rails PU = 10	sat. nickel black matt brushed gold	11473-100-29 -157 -209
	CEILING BRACKET 3 mm (System 13-) Single, ceiling extension 43 mm for rails PU = 10	silver white black	11592-00 -28 -157
	CEILING BRACKET 6 mm (System 14-) Single, ceiling extension 46 mm for rails PU = 2	sat. nickel black matt brushed gold	11590-1-29 -157 -209
	90°-CEILING BRACKET (System 17-) ceiling extension 40-48 mm (variabel) for rails PU = 10	silver white black	11588-00 -28 -157
	CEILING BRACKET 15 mm (System 15-) single, ceiling extension 55 mm for rails PU = 10	sat. nickel black matt brushed gold	11473-15-29 -157 -209
	CEILING BRACKET 35 mm single, ceiling extension 75 mm for rails PU = 10	sat. nickel black matt brushed gold	11473-35-29 -157 -209

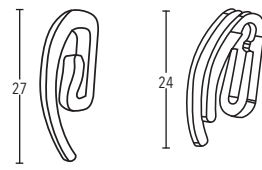
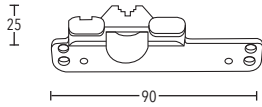
40 x 15 mm IQC Accessories

	ARTICLE	FINISH	ARTICLE-NO.
	WALL- AND CEILING BRACKET 43 mm (System 0-) single, wall extension 50 mm ceiling extension 83 mm for rails PU = 6	sat. nickel black matt brushed gold	11473-50-29 -157 -209
	WALL- AND CEILING BRACKET 73 mm (System 21-) single, wall extension 80 mm ceiling extension 113 mm for rails PU = 6	sat. nickel black matt brushed gold	11473-80-29 -157 -209
	EXTENSION (SQUARE) length 35 mm for brackets art. no. 11473-35, 11473-50 and 11473-80 PU = 6	sat. nickel black matt brushed gold	11473-2/2-29 -157 -209
	TRANSPORT CORD Role 250 metre Price € per metre	white grey black	8809-20-00 -08 -57
	TRANSPORT CORD CONNECTOR PU = 1	white grey black	8809-41-00 -08 -57
	GLIDER PU = 100	white grey black	8809-52-00 -08 -57
	CURTAIN HOOK CURTAIN DOUBLE HOOK PU = 100	white white	869-00 853-00
	MASTER CARRIER, UNDERLAP PU = 1	white grey black	8809-23-00 -08 -57

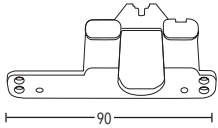
40 x 15 mm IQC Accessories

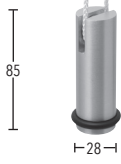
	ARTICLE	FINISH	ARTICLE-NO.
	MASTER CARRIER, OVERLAP PU = 1	white grey black	8809-24-00 -08 -57
	<hr/>		
	WAVE CARRIER PU = 1	white grey black	8809-34-00 -08 -57
	<hr/>		
	CORD WEIGHT CYLINDER weight approx. 140 g PU = 1	sat. nickel black matt brushed gold	11688-29 -157 -209
	<hr/>		
	CORD WEIGHT CYLINDER with rubber ring weight approx. 150 g PU = 1	sat. nickel black matt brushed gold	11689-29 -157 -209
	<hr/>		

40 x 15 mm IQC Illustrations



Wall bracket
art. no. 11473-50 + 11473-80

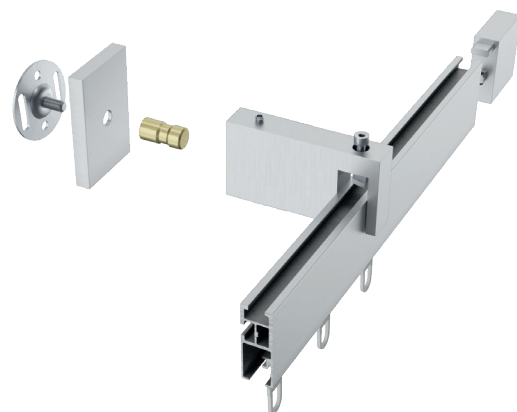
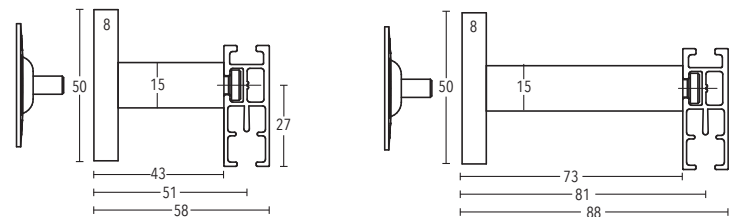

Wall bracket
art. no. 11570-80

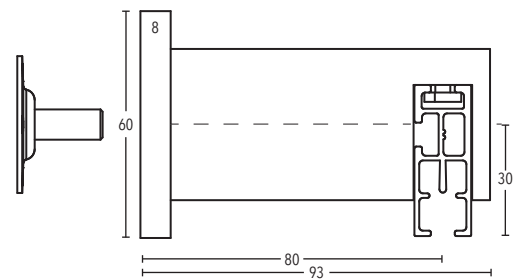

Wall bracket
art. no. 11570-2 + 11570-2-190

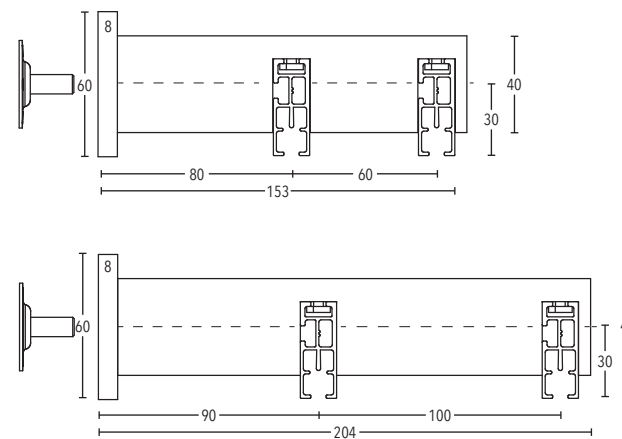

40 x 15 mm IQC Illustrations



Ceiling bracket 3 mm
art. no. 11592

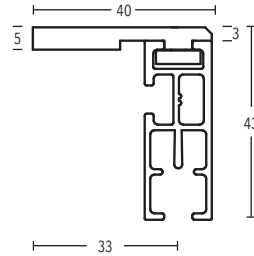

Ceiling bracket 15 mm + 35 mm
art. no. 11473-15 + 11473-35

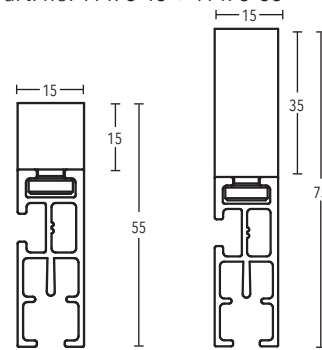

Ceiling bracket 43 mm + 73 mm
art. no. 11473-50 + 11473-80

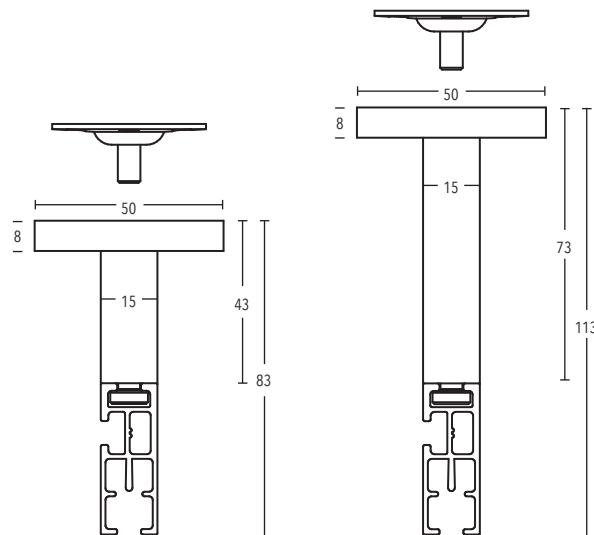

40 x 15 mm IQC Illustrations



Ceiling bracket 0-8 mm
art. no. 11588

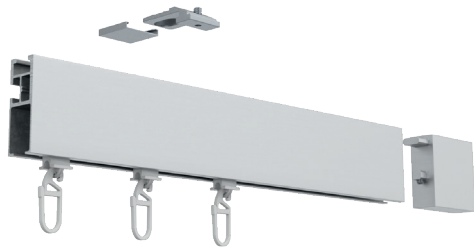
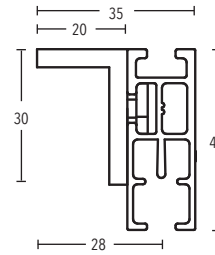

Ceiling bracket 3 mm
art. no. 11597

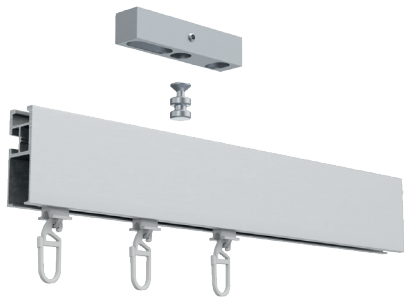
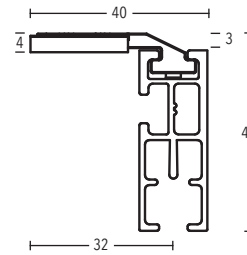

Ceiling bracket 15 mm
art. no. 11473-100

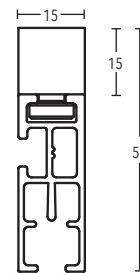

Ceiling bracket 6 mm
art. no. 11590-1

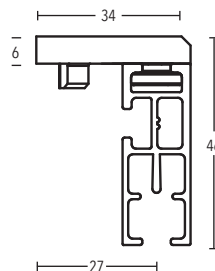

BÜSCHE

TECDOR IQ-Series

Ø 28 IQC - Corded pole sets

Ø 28 mm

black matt

Pole set no. 15-2860-157



Finishes:



-22 polished chrome



-29 sat. nickel



-157 black matt





Ø 28 mm IQC

WALL- AND CEILING INSTALLATION / Ø 28 mm / SINGLE/DOUBLE RAIL

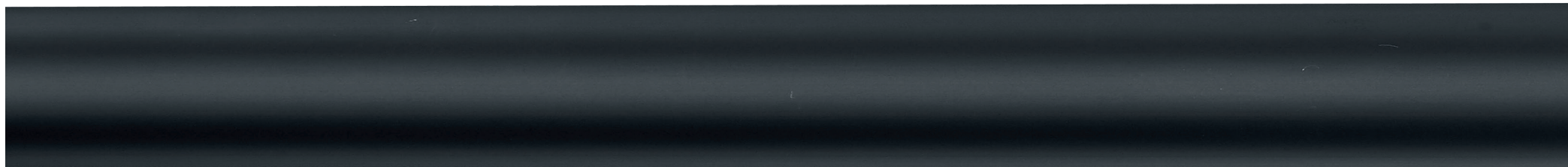

Ø 28 mm IQC - black matt - Page 190 - Pole set no. 4-2860-157



Ø 28 mm IQC - polished chrome - Page 190 - Pole set no. 4-2860-22

FINISHES AVAILABLE



-22 polished chrome

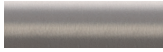

-29 sat. nickel



-157 black matt

Illustrations on a scale of 1 : 1



Ø 28 mm IQC Accessories

	ARTICLE	FINISH	ARTICLE-NO.	€ / PIECE
	ALUMINIUM-RAIL Ø 28 mm for corded pole sets Price € per metre Standard length 6 m	polished chrome sat. nickel black matt	809-28-22 -29 -157	Fix length 72,00 (cut to size) 72,00 € / m 45,60 Standard length 60,00 € / m 38,00
	PULLEY HOUSING for rail art. no. 809-28 PU = 1	polished chrome sat. nickel black matt	11687-22 -29 -157	70,00 70,00 70,00
	RETURN PULLEY for redirection the transport cord for rail art. no. 809-28 PU = 1	polished chrome sat. nickel black matt	11686-22 -29 -157	70,00 70,00 70,00
	RETURN PULLEY SHORT VERSION for redirection the transport cord for rail art. no. 809-28 PU = 1	polished chrome sat. nickel black matt	11683-41-22 -29 -157	56,00 56,00 50,00
	DOUBLE-RETURN PULLEY AND CONNECTOR for rail art. no. 809-28 to connect two corded pole sets, for deflecting the transport cord on both sides PU = 1	polished chrome sat. nickel black matt	11683-D-22 -29 -157	110,00 110,00 100,00
	WALL BRACKET (System 4-) single, wall extension 80 mm for rail art. no. 809-28 PU = 6	polished chrome sat. nickel black matt	11670-22 -29 -157	59,00 59,00 49,00
	WALL BRACKET single, wall extension 120 mm for rail art. no. 809-28 PU = 2	polished chrome sat. nickel black matt	11670-120-22 -29 -157	63,00 63,00 53,00
	WALL BRACKET (System 5-) double, wall extension 80/140 mm for rail art. no. 809-28 PU = 6	polished chrome sat. nickel black matt	11672-22 -29 -157	72,00 72,00 62,00



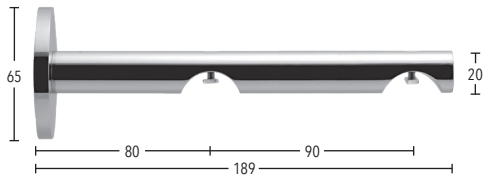
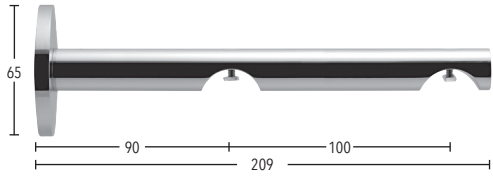
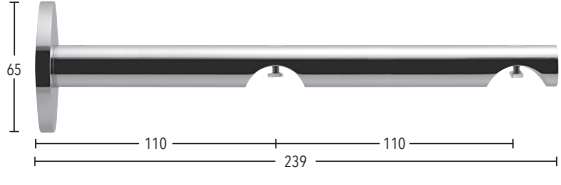
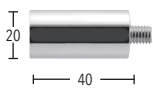
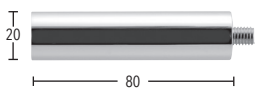
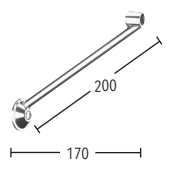
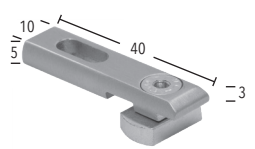



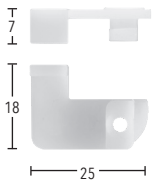
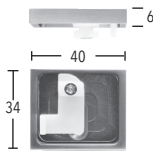
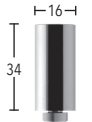
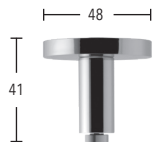
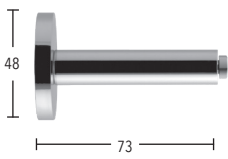
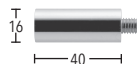
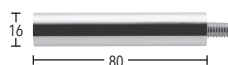

Ø 28 mm IQC Accessories

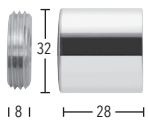
	ARTICLE	FINISH	ARTICLE-NO.
	WALL BRACKET double, wall extension 80/170 mm with large wall plate for rail art. no. 809-28 PU = 2	polished chrome sat. nickel black matt	11672-170-22 -29 -57
	WALL BRACKET double, wall extension 90/190 mm with large wall plate for rail art. no. 809-28 PU = 2	polished chrome sat. nickel black matt	11672-190-22 -29 -57
	WALL BRACKET double, wall extension 110/220 mm with large wall plate for rail art. no. 809-28 PU = 2	polished chrome sat. nickel black matt	11672-220-22 -29 -57
	EXTENSION length 40 mm for wall bracket art. no. 11670, 11672 PU = 2	polished chrome sat. nickel black matt	706-22 -29 -157
	EXTENSION length 80 mm for wall bracket art. no. 11670, 11672, PU = 2	polished chrome sat. nickel black matt	707-22 -29 -157
	SUPPORTING BRACKET can be cut for wall bracket art. no. 11670 and 11672 PU = 2	polished chrome sat. nickel black matt	11950-28.2-22 -29 -57
	CEILING BRACKET 3 mm (System 13-) single, ceiling extension 29 mm for rails PU = 10	silver white black	11592-00 -28 -157
	CEILING BRACKET 3 mm (System 11-) including drill hole cover single, ceiling extension 29 mm for rails PU = 10	silver white black	11597-00 -28 -157

Ø 28 mm IQC Accessories

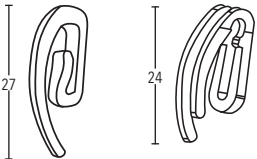
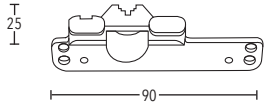
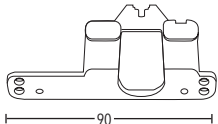
	ARTICLE	FINISH	ARTICLE-NO.
 <p>Technical drawing of a clamping ceiling bracket. Dimensions: height 18 mm, width 25 mm, and a small offset of 7 mm.</p>	CLAMPING CEILING BRACKET 3 mm single, ceiling extension 28 mm Material: plastic for rails PU = 10	white	11590-10-00
 <p>Technical drawing of a ceiling bracket. Dimensions: height 34 mm, width 40 mm, and a small offset of 6 mm.</p>	CEILING BRACKET 6 mm (System 14-) single, ceiling extension 32 mm for rails PU = 2	polished chrome sat. nickel black matt	11590-1-22 -29 -157
 <p>Technical drawing of a ceiling bracket. Dimensions: height 15 mm and width 14 mm.</p>	CEILING BRACKET 15 mm (System 15-) single, ceiling extension 41 mm for rails PU = 10	polished chrome sat. nickel black matt	11873-15-22 -29 -157
 <p>Technical drawing of a ceiling bracket. Dimensions: height 34 mm and width 16 mm.</p>	CEILING BRACKET 34 mm (System 16-) single, ceiling extension 60 mm for rails PU = 10	polished chrome sat. nickel black matt	11873-30-22 -29 -157
 <p>Technical drawing of a ceiling bracket. Dimensions: height 41 mm and width 48 mm.</p>	CEILING BRACKET 41 mm (System 17-) single, ceiling extension 67 mm for rails PU = 6	polished chrome sat. nickel black matt	11873-50-22 -29 -157
 <p>Technical drawing of a ceiling bracket. Dimensions: height 48 mm and length 73 mm.</p>	CEILING BRACKET 73 mm single, ceiling extension 99 mm for rails PU = 6	polished chrome sat. nickel black matt	11873-80-22 -29 -157
 <p>Technical drawing of an extension. Dimensions: height 16 mm and length 40 mm.</p>	EXTENSION length 40 mm for wall bracket art. no. 11873-50 and 11873-80 PU = 2	polished chrome sat. nickel black matt	11870-40-22 -29 -157
 <p>Technical drawing of an extension. Dimensions: height 16 mm and length 80 mm.</p>	EXTENSION length 80 mm for wall bracket art. no. 11873-50 and 11873-80 PU = 2	polished chrome sat. nickel black matt	11870-80-22 -29 -157

Ø 28 mm IQC Accessories

	ARTICLE	FINISH	ARTICLE-NO.
	RECESS BASKET for Ø 28 mm PU = 10	polished chrome sat. nickel black matt	122028-22 -29 -157
	TRANSPORT CORD Role 250 metre Price € per metre	white grey black	8809-20-00 -08 -57
	TRANSPORT CORD CONNECTOR PU = 1	white grey black	8809-41-00 -08 -57
	GLIDER PU = 100	white grey black	8809-52-00 -08 -57
	CURTAIN HOOK CURTAIN DOUBLE HOOK PU = 100	white white	869-00 853-00
	MASTER CARRIER, UNDERLAP PU = 1	white grey black	8809-23-00 -08 -57
	MASTER CARRIER, OVERLAP PU = 1	white grey black	8809-24-00 -08 -57
	WAVE CARRIER PU = 1	white grey black	8809-34-00 -08 -57
	CORD WEIGHT CYLINDER weight approx. 140 g PU = 1	polished chrome sat. nickel black matt	11688-22 -29 -157
	CORD WEIGHT CYLINDER with rubber ring weight approx. 150 g PU = 1	polished chrome sat. nickel black matt	11689-22 -29 -157

Ø 28 mm IQC Illustrations

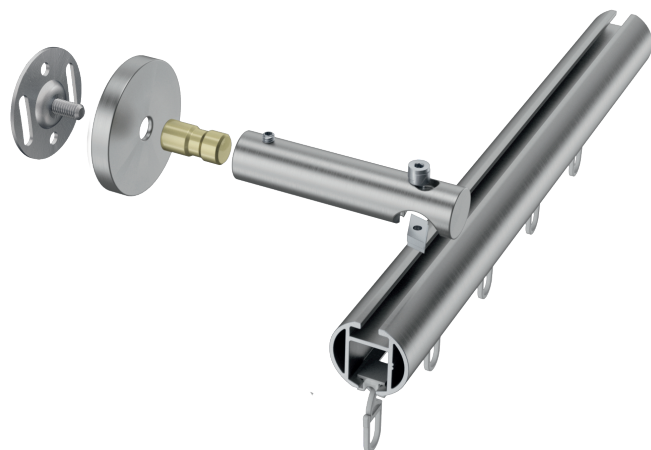

Wall bracket
art. no. 11670 + 11670-120

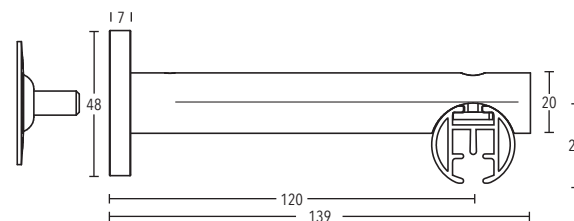
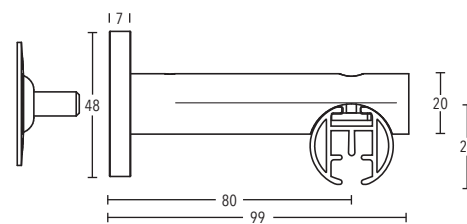

Wall bracket
art. no. 11672-170 + 11672-190 + 11672-220

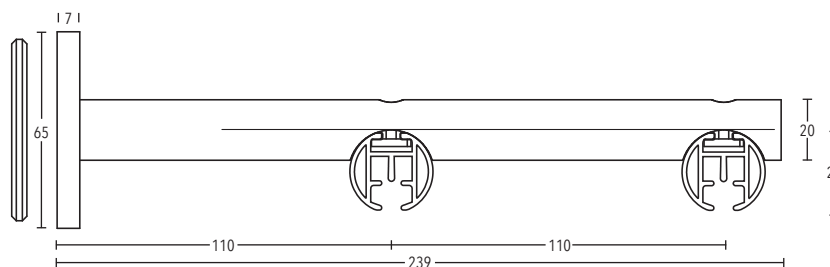
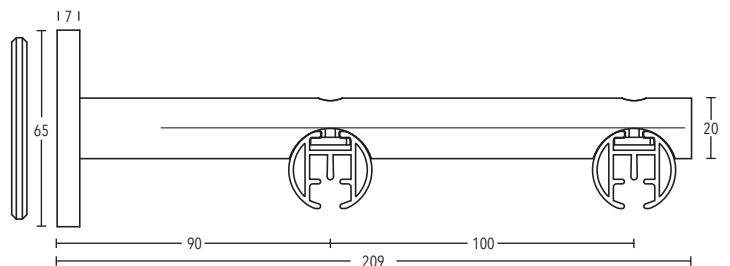
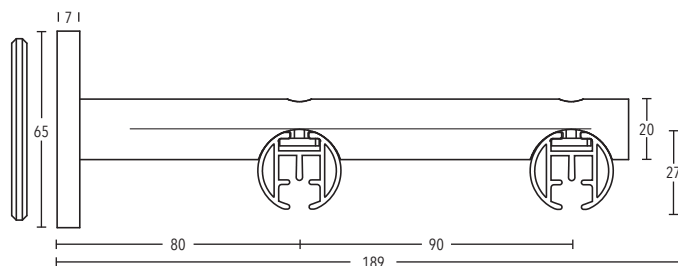

Ø 28 mm IQC Illustrations

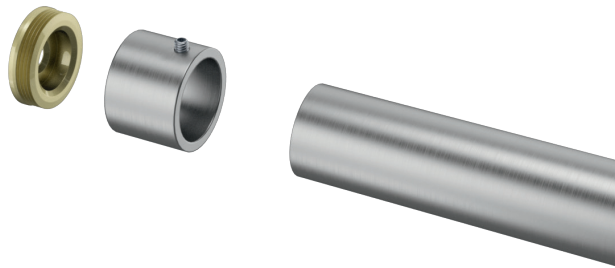

Recess basket
art. no. 122028

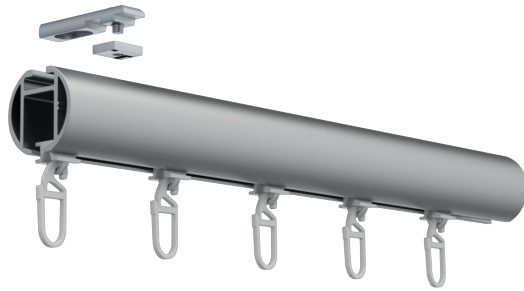
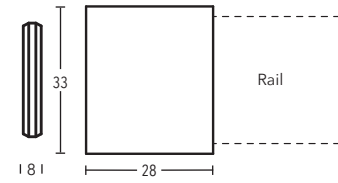

Ceiling bracket 3 mm
art. no. 11592

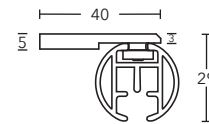

Ceiling bracket 3 mm
art. no. 11597

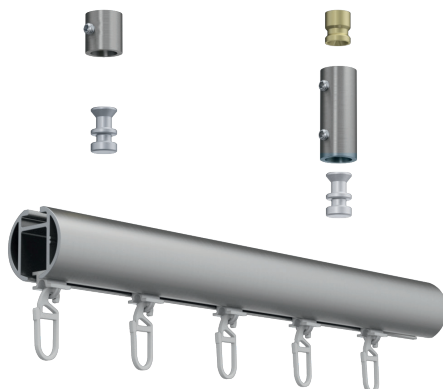
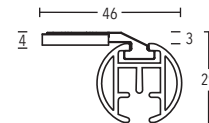

Ceiling bracket 15 mm + 34 mm
art. no. 11873-15 + 11873-30

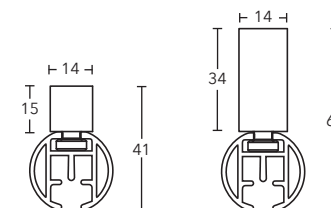

Ø 28 mm IQC Illustrations



Ceiling bracket 41 mm + 73 mm
art. no. 11873-50 + 11873-80

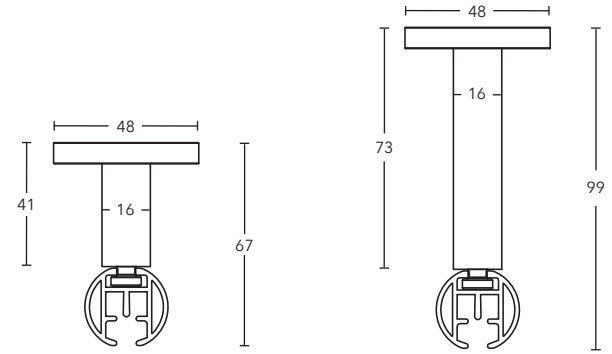

BÜSCHE

TECDOR IQ-Series

Ø 40 IQC - Corded pole sets

Ø 40 mm

white

Pole set no. 4-4060-28

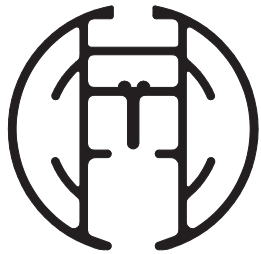

Finishes:



-28 white



-29 sat. nickel



-157 black matt





Ø 40 mm IQC

WALL- AND CEILING INSTALLATION / Ø 40 mm / SINGLE/DOUBLE RAIL



Ø 40 mm IQC - black matt - Page 204 - Pole set no. 15-4060-157



Ø 40 mm IQC - white - Page 204 - Pole set no. 4-4060-28



FINISHES AVAILABLE



-28 white

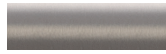

-29 sat. nickel



-157 black matt

Illustrations on a scale of 1 : 1

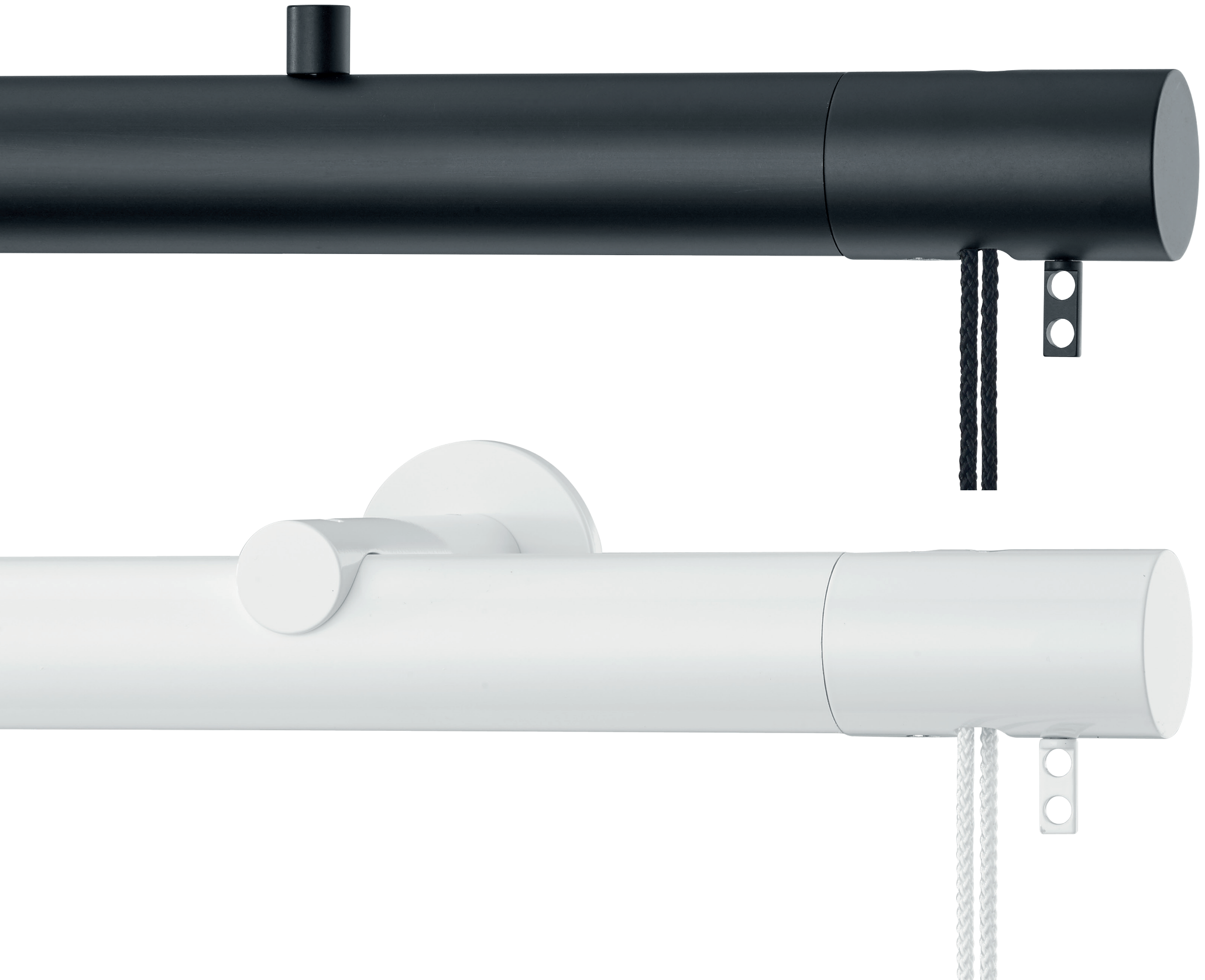







Ø 40 mm IQC Accessories

	ARTICLE	FINISH	ARTICLE-NO.		
	ALUMINIUM-RAIL Ø 40 mm for corded pole sets Standard length 6 m	white sat. nickel black matt	809-40-28 -29 -157	Fix length (cut to size)	Standard length
	PULLEY HOUSING for rail art. no. 809-40 PU = 1	white sat. nickel black matt	11687-40-28 -29 -157		
	RETURN PULLEY for redirection the transport cord for rail art. no. 809-40 PU = 1	white sat. nickel black matt	11686-40-28 -29 -157		
	WALL BRACKET (System 4-) single, wall extension 100 mm for rail art. no. 809-40 PU = 6	white sat. nickel black matt	40970-28 -29 -157		
	WALL BRACKET single, wall extension 100 mm with large wall plate 65 mm for rail art. no. 809-40 PU = 2	white sat. nickel black matt	40870-28 -29 -157		
	WALL BRACKET (System 5-) double, wall extension 100/200 mm with large wall plate 65 mm for rail art. no. 809-40 PU = 2	white sat. nickel black matt	40872-28 -29 -157		
	WALL BRACKET double, wall extension 110/235 mm with large wall plate 65 mm for rail art. no. 809-40 PU = 2	white sat. nickel black matt	40872-235-28 -29 -157		
	EXTENSION length 40 mm for wall bracket art. no. 4087x and 4097x PU = 2	white sat. nickel black matt	806-28 -29 -157		

Ø 40 mm IQC Accessories

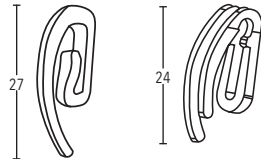
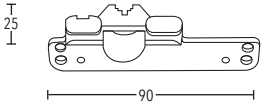
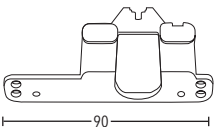
	ARTICLE	FINISH	ARTICLE-NO.
	CEILING BRACKET 3 mm (System 13-) Single, ceiling extension 42 mm for rails PU = 10	silver white black	11592-00 -28 -157
	CEILING BRACKET 15 mm (System 15-) single, ceiling extension 54 mm for rails PU = 10	white sat. nickel black matt	11873-15-28 -29 -157
	CEILING BRACKET 35 mm (System 16-) single, ceiling extension 73 mm for rails PU = 10	white sat. nickel black matt	11873-30-28 -29 -157
	CEILING BRACKET 41 mm (System 17-) single, ceiling extension 80 mm for rails PU = 10	white sat. nickel black matt	11873-50-28 -29 -157
	CEILING BRACKET 73 mm single, ceiling extension 112 mm for rails PU = 10	white sat. nickel black matt	11873-80-28 -29 -157
	EXTENSION length 40 mm for wall bracket art. no. 11873-50 and 11873-80 PU = 2	white sat. nickel black matt	11870-40-28 -29 -157
	EXTENSION length 80 mm for wall bracket art. no. 11873-50 and 11873-80 PU = 2	white sat. nickel black matt	11870-80-28 -29 -157
	RECESS BASKET for Ø 40 mm PU = 10	white sat. nickel black matt	122040-28 -29 -157
	TRANSPORT CORD Role 250 metre	white grey black	8809-20-00 -08 -57

Ø 40 mm IQC Accessories

	ARTICLE	FINISH	ARTICLE-NO.
	TRANSPORT CORD CONNECTOR PU = 1	white	8809-21-00
	GLIDER PU = 100	white grey black	8809-52-00 -08 -57
	CURTAIN HOOK CURTAIN DOUBLE HOOK PU = 100	white white	869-00 853-00
	MASTER CARRIER, UNDERLAP PU = 1	white grey black	8809-23-00 -08 -57
	MASTER CARRIER, OVERLAP PU = 1	white grey black	8809-24-00 -08 -57
	WAVE CARRIER PU = 1	white grey black	8809-34-00 -08 -57
	CORD WEIGHT CYLINDER weight approx. 140 g PU = 1	white sat. nickel black matt	11688-28 -29 -157
	CORD WEIGHT CYLINDER with rubber ring weight approx. 150 g PU = 1	white sat. nickel black matt	11689-28 -29 -157

Ø 40 mm IQC Illustrations

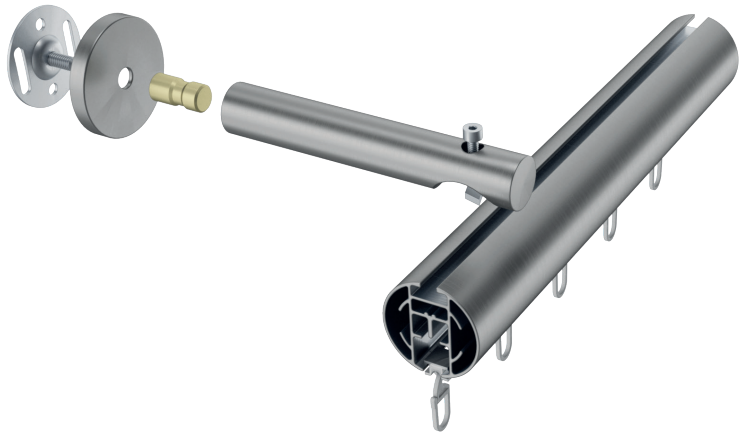

Wall bracket
art. no. 40970

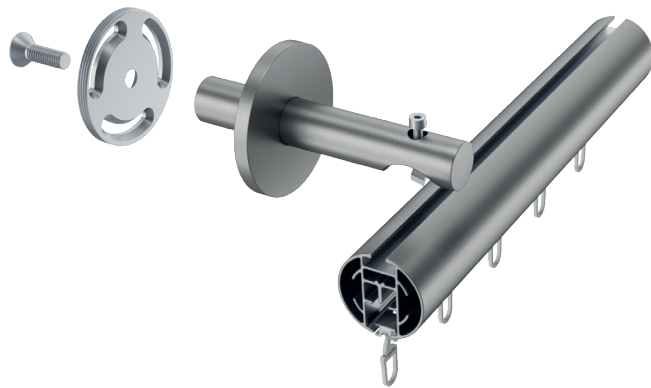
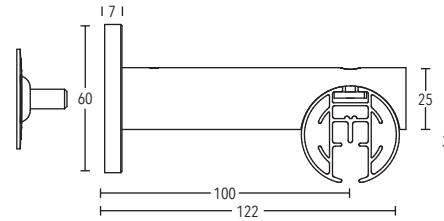

Wall bracket
art. no. 40870

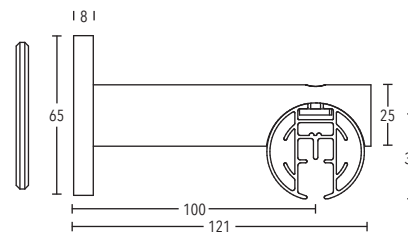

Wall bracket
art. no. 40872 + 40872-235

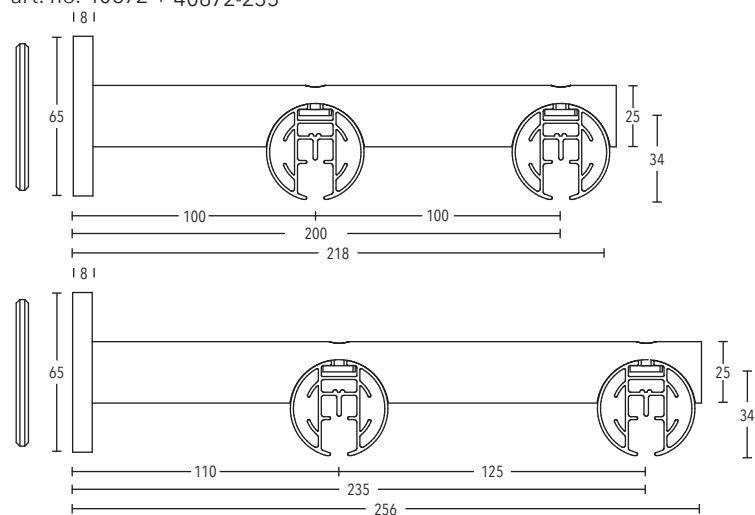

Ø 40 mm IQC Illustrations



Ceiling bracket 3 mm
art. no. 11592

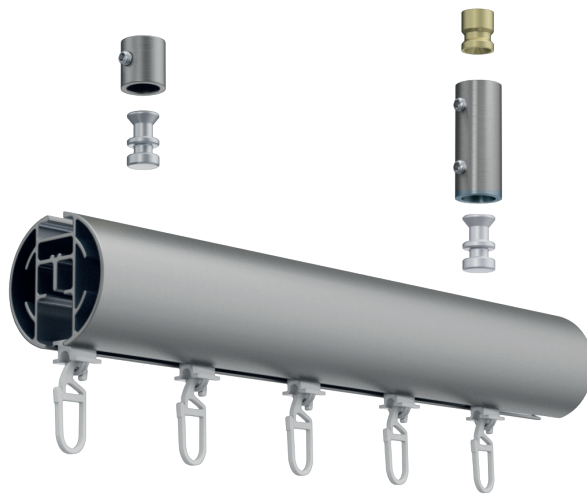
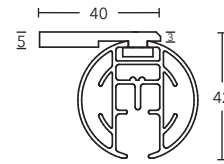

Ceiling bracket 15 mm + 34 mm
art. no. 11873-15 + 11873-30

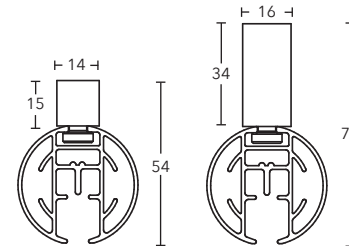

Ceiling bracket 41 mm + 73 mm
art. no. 11873-50 + 11873-80

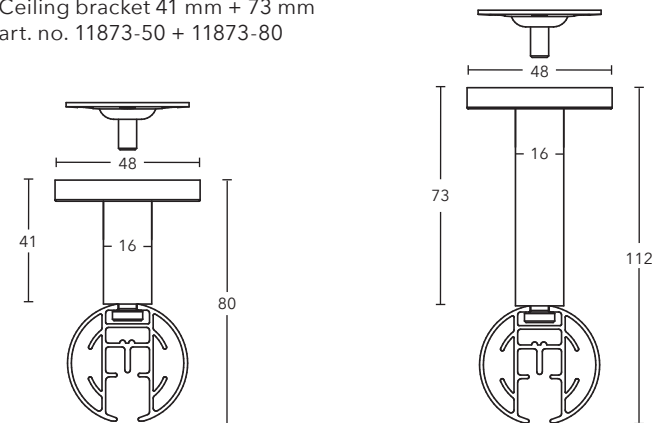

Ø 40 mm IQC Illustrations

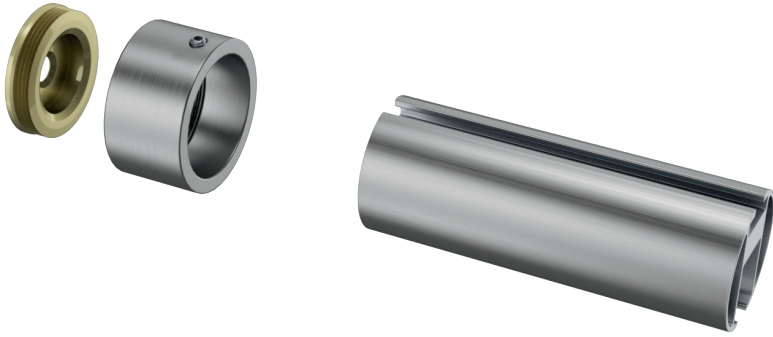

Recess bucket
art. no. 122040

